

**100 Use of “extended clearance concept” in new drug discovery and development; Prediction of the effect of drug-drug interaction and pharmacogenomics on PK/PD/TD of drugs**

Yuichi Sugiyama, Sugiyama Laboratory, RIKEN, Yokohama, Japan

In this presentation, I will summarize the significant role played by drug transporters in drug disposition, focusing particularly on their roles in the PK/PD/TD of drugs. Even when drugs ultimately undergo metabolism and/or biliary excretion in the liver, their elimination rate is sometimes determined by the hepatic uptake rate mediated by uptake transporters. Elucidation of the rate-determining process is therefore critical for predicting their hepatic clearance, and their systemic and regional exposures. I will show you how to understand the so-called “Extended clearance concept (ECC)” that includes the passive transport and transporter-mediated membrane transport and enzyme-mediated metabolism processes and to investigate the effect of changes in transporter (influx, efflux) function and metabolizing enzyme function on the pharmacokinetics of drugs in the blood and the liver and, ultimately, the pharmacological and/or toxicological effects (1-2). The use of transporter function offers the possibility of delivering a drug to the target organ, avoiding distribution to other organs (thereby reducing the chance of toxic side-effects), controlling the elimination process, and/or improving oral bioavailability. For drugs, the target molecule of which is inside the cells, the efflux transporter is the determinant for their pharmacological effect or adverse reactions even though it had negligible impact on the plasma concentrations. Development of probe substrates applicable to the PET imaging will elucidate the quantitative relationship between the transport activities and drug response. Drug transporters are also important for the disposition of endogenous and food derived compounds.

**References:**

- 1) Giacomini KM and Sugiyama Y. Membrane transporters and drug response, in “Goodman & Gilman's The Pharmacological Basis of Therapeutics 13<sup>th</sup> Edition”, (Brunton LL, Dandan RH, Knollman B, eds) Chapter 5, Section 1, McGraw-Hill Companies, New York, NY, pp 65-84 (2018).
- 2) Yoshida K, Maeda K, Sugiyama Y. Hepatic and Intestinal Drug Transporters: Prediction of Pharmacokinetic Effects Caused by Drug-Drug Interactions and Genetic Polymorphisms. *Annu Rev Pharmacol Toxicol.* 53: 581-612 (2013)

**101 Reflections and connections on a pharmacokinetic journey**

Kevin T Batty, School of Pharmacy, Curtin University, Perth, WA, Australia

**Introduction:** The rich Australian landscape of pharmaceutical and pharmacological sciences is populated by generous researchers who assist students and academics along the path of innovation and scientific discovery.

**Aim:** This presentation describes a journey of antimalarial and antimicrobial pharmacokinetic research, highlighting research collaborations and reflecting on an individual's contribution to the team. The shared purpose has been to improve the treatment of infectious diseases, especially in vulnerable populations.

**Discourse:** The artemisinin antimalarial drugs were emerging as important therapeutic agents in the 1990s. However, there was a paucity of pharmacokinetic (PK) data at the time and analytical techniques were problematic. Enthused by the prospect of a research project which the supervisors deemed plausible, the journey began. In the fullness of time, aided by advice and support from numerous experts in their field, our contributions included PK data for artesunate and its active metabolite, dihydroartemisinin, in Vietnamese patients, and evidence that artesunate was a prodrug.

A subsequent phase of research for the next generation of doctoral students focussed on a murine malaria model for pharmacokinetic-pharmacodynamic (PKPD) and toxicokinetic investigations. New collaborations included expertise in PKPD modelling, to optimise the use of rich data in sophisticated models.

Entering the classroom, PowerPoint and clinical pharmacokinetics have replaced chalk, blackboards and differential calculus. The PK jargon includes feathering, well stirred models and  $f_u$ . We focus on competent mathematical skills, an understanding of the principles and applying PK knowledge in the context of optimising patient outcomes.

Now it is the era of sparse sampling, pharmacometricians, microvolume blood samples and liquid chromatography-mass spectrometry (LCMS) analysis. Our foray into dried blood spot assays has been based on the goal to minimise invasive blood samples and extend the scope of PK studies in field settings where laboratory equipment is non-existent. Blood volumes are <50  $\mu$ L and dried on paper cards, compared to 2-3 mL samples for centrifugation and separation of plasma for frozen storage. The enticing prospect of PK studies in remote settings and paediatric or neonatal populations is accompanied by a new paradigm in assay validation and biopharmaceutical science, and the privilege of collaborating with highly committed researchers whose mission is to improve patient care.

**102 Understanding cannabinoid clinical pharmacology in order to drive clinical studies**

Catherine J Lucas<sup>1</sup>, Jennifer Schneider<sup>2</sup>, Peter Galettis<sup>1</sup>, Jennifer H Martin<sup>1</sup>, <sup>1</sup>Discipline of Clinical Pharmacology, University of Newcastle, Newcastle, NSW, Australia; <sup>2</sup>School of Biomedical Sciences and Pharmacy, University of Newcastle, Newcastle, NSW, Australia

**Introduction:** Interest in the medicinal uses of cannabinoids is increasing. There is, however, a current lack of good quality evidence pertaining to the complex pharmacology and physiological effects of exogenous cannabinoids in humans, administered either as extracts or the whole plant. Understanding of basic pharmacetics, pharmacokinetics and pharmacodynamics for different parts of the cannabis plant is essential to guide safe dosing and reduce toxicity.

**Aims:** To outline the key pharmacological knowledge required to guide further exploration of the efficacy and toxicity of different cannabinoids and formulations in blinded, placebo-controlled studies.

**Discussion:** There is a need for pharmacological knowledge on the difference of the whole plant compared with numerous different individual chemicals, many of which are known to contribute to the pharmacological and toxicological properties of cannabis. Varying levels of these compounds may produce different physiological effects. Omission of animal studies limits knowledge of toxicity and median lethal dose pivotal to guiding dosing in early phase human studies. The absorption of cannabinoids differs with route of administration and bioavailability is variable with all modes of administration. Diet, microbiome, pharmacogenetics, body composition and other unknown patient factors influence absorption, metabolism and elimination. Cannabinoids may accumulate in tissues, with variable release from lipid storage compartments. Metabolism is predominantly hepatic (but also occurs in extra-hepatic tissues) and as such, there is significant potential for drug-drug interactions. Important active metabolites of  $\Delta^9$ -tetrahydrocannabinol and cannabidiol can have pharmacodynamic effects. Understanding the clinical pharmacology of cannabinoids is critical for maximising therapeutic effects and minimising negative side effects and for regulatory support to enable human use.

Martin JH et al. (2017) Clin Pharmacokinet DOI 10.1007/s40262-017- 0599-0

**103 Cannabinoids for patients: Comparative efficacy and toxicity in paediatric setting**

Noel E Cranswick, Department of Pharmacology, University of Melbourne, Parkville, VIC, Australia

The off-label use of cannabis products in children has rapidly increased over the last few years in Australia, mostly for the treatment of drug-resistant epilepsy. Up until recently, many children have received extemporaneously produced products from back-yard operations. Many of these products have been produced illegally and are of unknown quality with no specific safety information available. Until recently, all of the experience in the use of cannabinoids was anecdotal with emotive reports of vast improvement in severely affected children. There are now some data from randomised trials with some evidence of efficacy but significant side-effects associated with the use of cannabidiol (CBD) in Dravet syndrome and Lennox-Gastaut syndrome. Mostly as the result of political processes, there is increasing use of CBD in Australian children who suffer from a variety of drug-resistant epilepsy syndromes. The details of the access schemes and available products varying from State to State. The Victorian experience, in an open-label access scheme, is that the apparent rate of improvement and side-effects is similar to that reported in the clinical trials. There is evidence of a specific and highly clinically relevant drug interaction between CBD and clobazam resulting in an increased rate of adverse events as well as some improvement in seizure control. Further studies are needed to better define the role of CBD in the treatment of children with drug-resistant epilepsy before it can be recommended in routine clinical practice.

Devinsky O et al (2017) N Engl J Med 2017; 376:2011-2020

French J et al (2017) Neurology April 18, 2017 vol. 88 no. 16 Supplement S21.001

**104 High quality human cannabinoid analytics to drive clinical studies**

Peter Galettis<sup>1,2,3</sup>, <sup>1</sup>Discipline of Clinical Pharmacology, University of Newcastle, <sup>2</sup>Callaghan NSW, Hunter Medical Research Institute, New Lambton Heights NSW, <sup>3</sup>Australian Centre for Cannabinoid Clinical and Research Excellence (ACRE)

There is increasing interest in the use of cannabis for medicinal purposes. However the term medicinal cannabis refers to a number of different products, including Cannabis Flos, Cannabis Oils and THC or CBD extracts from plants. In order to know the characteristics of the products being administered to patients in clinical studies, it is firstly important to have a clear indication of which cannabinoids and the relative amounts of each cannabinoid that are present in these materials. This requires development of reliable and robust analytical techniques capable of both separating each of the different cannabinoids and also determining the concentrations of each cannabinoid present. Once the cannabinoids and the amount present in a particular product is known, it is then possible to develop analytical methods for the determination of cannabinoids in human plasma or other biological fluid samples obtained when these products are administered in a clinical trial. The two main active cannabinoids in cannabis are currently considered to be THC and CBD. Once either THC or CBD enter the body they are then metabolised significantly to a number of metabolites with the main ones being hydroxyl THC, carboxy THC and the carboxy THC glucuronide as well as the equivalents for CBD. However, in the cannabis plant these compounds are present predominantly in the carboxylated form (THCA and CBDA) and require decarboxylation to be converted to THC and CBD. This is usually achieved by heating the plant material either by smoking or some form of vaporisation. This presentation will discuss a number of issues involved in developing analytical methods for a complex material such as cannabis. It will also discuss factors to be considered in developing analytical methods for measuring cannabinoids and their metabolites in biological fluid.

**105 Pharmacokinetic analysis of vaporized cannabinoids through inhalation**

Zheng Liu<sup>1,2</sup>, Noel Cranswick<sup>2</sup>, Jennifer Martin<sup>1</sup>, <sup>1</sup>School of Medicine and Public Health, University of Newcastle, Callaghan, NSW, Australia, <sup>2</sup>Clinical Pharmacology, Department of Medicine, The Royal Children's Hospital Melbourne, Australia

Medicinal cannabinoids have gained significant attention recently, due to potential benefits in therapeutic applications. The most important two components for clinical use are  $\Delta^9$ -tetrahydrocannabinol (THC) and cannabidiol (CBD). There is currently little high quality evidence however people have used these therapies to treat a wide variety of symptoms such as distress, pain relief and anxiety. Developing high quality evidence requires knowledge about the pharmacology, prior to undertaking clinical trials. Pharmacology of these therapies are complex as they are lipophilic and patients often use a mix of oral, intravenous, and pulmonary routes. In the absence of clinical trial and pharmacology data for all routes, indications, and population groups, population modelling is required to help predict dosing. We have developed several preliminary modeling projects to understand the pharmacology of cannabinoid therapies used in the clinical trial setting here in Australia. In this presentation we discuss the issues regarding dosing in these studies and the methods used. This work has enabled the pharmacokinetic models for THC and CBD to be developed and the relevant parameter values estimated. The resultant pharmacokinetic information revealed will help clinicians understand the pharmacokinetic information of cannabinoids. Specifically, the developed pharmacokinetic models can be used to forecast concentration profiles of the drug under many different dosing regimens and assess the drug accumulation in a multiple-dose setting. This provides the good opportunity for dosing optimization and improve decision making in future clinical trials.

[1] Grotenhermen F: Pharmacokinetics and pharmacodynamics of cannabinoids. Clin Pharmacokinetics 2003, 42:327–360.

**106 Pharmaceutical Aspects of Cannabis**

Jennifer J Schneider, School of Biomedical Sciences and Pharmacy, University of Newcastle, Callaghan, NSW, Australia

According to recorded history, Cannabis has been used as a medicine for thousands of years with different parts of this plant being administered topically, orally or smoked for pharmacological effect. Use of cannabis in Western Medicine was reported in the 19<sup>th</sup> and 20<sup>th</sup> century and its use began to wane in the 1940s-largely due to the availability of other medicines and the impact of government legislation. In the last decade, there has been a resurgence in interest in the medicinal use of cannabis for treating different conditions. This rise in popularity has seen many different forms of cannabis become available. These include “medibles” (edible forms of marijuana), home grown products and pharmaceutical grade formulations. While modern pharmaceutical dosage forms generally consist of a single drug or a combination of two or three drugs for which specific dosage form testing criteria are clearly defined in pharmacopoeias, the re-emergence of cannabis for therapeutic use has taken us back to a time when tinctures and extracts made up most of the entries in pharmacopoeias. The complexity of working with plant extracts instead of a single drug entity presents challenges in ensuring patients receive consistent doses of the extracted material, that different extracts contain the same ingredients, that formulations maintain potency on storage and there is reproducible bioavailability of the medicinal agents. This presentation will explore the pharmaceutical aspects of cannabis and cannabinoid products including formulations, routes of delivery, stability and factors influencing bioavailability.

**107 Cytochrome P450 structure-function: Insights from molecular dynamics simulations**

Pramod C Nair<sup>1,2</sup>, Ross A McKinnon<sup>2</sup>, John O Miners<sup>1,2</sup>, <sup>1</sup>Department of Clinical Pharmacology, <sup>2</sup>Flinders Centre for Innovation in Cancer, Flinders University, Adelaide, SA

Cytochrome P450 (CYP) enzymes from families 1, 2 and 3 play an essential role in the metabolic clearance and detoxification of a myriad of drugs and non-drug xenobiotics. Although experimental techniques such as X-ray crystallography have provided valuable information relating to CYP structure-function, the structures elucidated by X-ray crystallography are static and data are limited in terms of the thermodynamics of binding and understanding the flexibility of CYP enzyme active sites. We have utilized Molecular Dynamics Simulations (MDS) to model the thermodynamics and flexibility of CYP2C9 in order to elucidate the importance of protein plasticity in substrate binding. CYP2C9 primarily metabolises weakly acidic drugs (e.g. NSAIDs, phenytoin, S-warfarin), but also has the capacity to metabolise some basic drugs (e.g. amitriptyline). Initial studies demonstrated that simulation times of 100 ns and longer were necessary to adequately model the conformational flexibility of CYP2C9. Distance mapping between the C $\alpha$  atoms of substrate recognition sites (SRSs) and the heme Fe atom (as the reference point) of the CYP2C9 catalytic site shows SRS1 (B-C loop, which lies between helices B and C) and SRS3 (helix G) as the most flexible regions of this enzyme. On the other hand, the least malleable regions were SRS2 and SRS4. The structural flexibility of SRS1 and SRS3 facilitates the binding of diverse ligands of different molecular shape and size. MD simulations further demonstrated that the binding of acidic (carboxylic acids) and basic (amines) drugs to CYP2C9 occurs by subtle conformational readjustment of amino acids within the active site. The binding of acidic substrates within the CYP2C9 active site is mediated mainly via a combination of H-bonding (Arg-108) and aromatic hydrophobic (Phe-114 and Phe-476) interactions. By comparison, the basic substrates predominantly bind within the CYP2C9 active site via aromatic hydrophobic (Phe-114 and Phe-476) interactions. MDS additionally provides insights into the mechanisms of drug-drug interactions, for example the heterotropic activation of flurbiprofen by dapson. Binding of dapson induces a conformational change in the B-C loop of CYP2C9 allowing formation of a salt-bridge between Arg-105 and the sulfone group of dapson. This positioning of dapson in turn stabilises the binding of flurbiprofen (via pi-pi interactions) and ‘tightens’ the active site, resulting in a more favourable orientation of flurbiprofen for catalysis with an increase in maximal velocity (and hence intrinsic clearance).

**108 CYP2J2 over-expression in breast cancer cells drives tumourigenesis and anti-cancer drug resistance**

Michael Murray<sup>1</sup>, Nenad Petrovic<sup>2</sup>, Peter I Mackenzie<sup>3</sup>, Sarah E Allison<sup>1</sup>, <sup>1</sup>Department of Pharmacology, University of Sydney<sup>1</sup>, Sydney, NSW, <sup>2</sup>School of Pharmacy and Medical Science, University of South Australia, Adelaide, SA, <sup>3</sup>Clinical Pharmacology, Flinders University<sup>3</sup>, Bedford Park, SA

**Introduction:** Cytochrome P450 2J2 (CYP2J2) is over-expressed in many human cancers and generates tumourigenic epoxyeicosatrienoic acids (EETs) from arachidonic acid, but the underlying mechanisms are unclear.

**Aims:** We have addressed the mechanisms by which EETs regulate tumourigenesis in human breast-derived cell lines.

**Methods:** MDA-MB-468 breast cancer cells were stably transfected with human CYP2J2 (MDA-2J2 cells) and Affymetrix microarray profiling was undertaken. Cell viability was assessed using MTT reduction and ATP formation, apoptosis using caspase-3 activity, cell migration using a 3D-matrigel droplet assay, and reactive oxygen species (ROS) using 2',7'-dichlorofluorescein diacetate and flow cytometry. Gene expression was evaluated using RT-PCR and protein expression by western immunoblotting. Gene silencing was undertaken using specific siRNAs.

**Results:** The proliferative and migratory capacities of MDA-2J2 cells were enhanced over MDA-CTL. 182 genes were differentially expressed in MDA-2J2 cells relative to control (MDA-CTL) cells (log-fold  $\geq 2$ ). From pathway analysis bone morphogenetic protein receptor 1B (BMPR1B) and aldehyde dehydrogenase 1A1 (ALDH1A1) were two genes of interest that were upregulated and functional in MDA-2J2 cells. Addition of the BMPR1B ligand BMP2 stimulated the migration of MDA-2J2 cells, but not MDA-CTL cells, from matrigel droplets. Cell killing by the major breast cancer drug paclitaxel was impaired in MDA-2J2 cells compared to MDA-CTL. Basal and paclitaxel-activated ROS content was lower, and the paclitaxel-mediated formation of protein adducts by reactive aldehydes derived from lipid peroxidation was attenuated in MDA-2J2 cells. Silencing of ALDH1A1 restored the sensitivity of MDA-2J2 cells to paclitaxel and formation of ROS to levels comparable with MDA-CTL. Doxorubicin, sorafenib and staurosporine also promoted ROS-mediated cell death that was attenuated in MDA-2J2 cells and was reversed by ALDH1A1 gene silencing.

**Discussion:** Over-expression of CYP2J2 in MDA-2J2 cells activates the expression of BMPR1B, which promotes migration, and ALDH1A1, which modulates ROS production by anti-cancer agents and diminishes their efficacy. Novel approaches to target BMPR1B and ALDH1A1 may inhibit migration and drug resistance in breast cancers that over-express CYP2J2.

**109 Regulation and function of UGTs in cancer**

Robyn Meech<sup>1,2</sup>, Dong Gui Hu<sup>1</sup>, Apichaya Chanawong<sup>1</sup>, Lu Lu<sup>1</sup>, Ross A McKinnon<sup>1,2</sup>, and Peter I Mackenzie<sup>1</sup>, <sup>1</sup>Department of Clinical Pharmacology, Flinders University. <sup>2</sup> Flinders Centre for Innovation in Cancer, Flinders University, Bedford Park, SA, Australia

**Introduction:** UDP Glucuronosyltransferases play critical roles in the elimination of numerous therapeutic drugs as well as endogenous lipophilic molecules such as steroid hormones. UGTs are often regulated by ligands that are also UGT-substrates, thus generating regulatory loops through which small molecules control their own metabolism. There is evidence that UGT activity influences the progression of steroid-dependent cancers (breast and prostate) via glucuronidation of growth-promoting steroids. In addition UGTs conjugate several steroidal anti-cancer drugs and cytotoxic anti-cancer drugs, and this may influence therapy response and the acquisition of drug resistance.

**Aims:** To understand the mechanisms of local regulation of UGTs in cancer cells by steroids and by various classes of anti-cancer drugs, and how this regulation may influence cancer cell growth and response to therapy.

**Methods:** A suite of gene regulation analysis tools is used to understand how multiple UGTs are regulated in cancer cells by steroids, steroidal anti-cancer drugs, and cytotoxic anti-cancer drugs. We also examine how UGT overexpression or ablation affects cancer cell growth and drug resistance.

**Results:** Results of studies in two areas are presented. 1. We show the mechanisms by which UGT2B15 and UGT2B17 are induced in breast cancer by natural steroids and by the selective estrogen receptor modulators Tamoxifen and the aromatase inhibitor Exemestane. We present data on the effects of loss and gain of UGT2B15/17 function in breast cancer cells. 2. We show the mechanisms of UGT induction by cytotoxic anti-cancer drugs in cancer cells, and also provide evidence that UGT expression can be constitutively elevated in cancer stem cells. We present data on the effects of loss and gain of UGT function on cancer cell drug response/drug resistance.

**Discussion:** Our studies indicate that UGT expression and regulation may be an important variable in cancer progression and drug resistance. Opportunities to modulate UGTs for therapeutic benefit in cancer will be discussed.

**110 Arylamine N-acetyltransferase-1: Drug metabolism and more**

Neville J Butcher, Lili Wang, Peng cheng Li, Rodney F Minchin, School of Biomedical Sciences, University of Queensland, Brisbane, QLD, Australia

The arylamine N-acetyltransferases (NATs; EC 2.3.1.5) are a family of highly conserved phase II xenobiotic-metabolising enzymes that are found in both prokaryotes and eukaryotes. In humans, there are two functional enzymes, NAT1 and NAT2. Both NAT genes are genetically polymorphic, which, combined with post-transcriptional regulation, results in highly variable NAT enzyme activities, both between and within individuals. Although this variability in NAT enzyme activity affects the susceptibility of individuals to drug toxicity and various cancers, there is a growing body of evidence that suggests the NAT1 isozyme has an important physiological role in the cell in addition to xenobiotic metabolism. NAT1 is a ubiquitously expressed protein and is also found in all immortalised cancer cell lines tested to date, albeit at very different levels. We, and others, have used various strategies to manipulate NAT1 expression/activity in human cancer cell lines in order to investigate its role in cancer cell biology. Several different phenotypes have been observed, including changes in cancer cell metabolism, growth and survival, gene expression, invasion, and sensitivity to chemotherapeutics. The exact molecular mechanism/s linking NAT1 to these phenotypes is yet to be determined, but appears to involve changes in the acetylome. Using CRISPR-generated NAT1 knock-out cell models, we have identified changes in the lysine acetylation of several important proteins, including p53, sirtuins 1 and 2, and ACS2. Although NAT1 is unable to acetylate proteins itself, we have recently discovered that it interacts with the acetyltransferase p300/CBP and can modulate its activity. We hypothesise that NAT1 is a key regulator of p300/CBP acetyltransferase activity.

**111 Sulfotransferase: Structure, function and protein-protein interactions**

Rodney F Minchin, Misgana Idris and Neville J Butcher, School of Biomedical Sciences, University of Queensland, Brisbane, QLD, Australia

The cytosolic sulfotransferases (SULTs) are responsible for the sulfonation of numerous endogenous hormones and neurotransmitters as well as therapeutic agents and environmental toxins. Variability in sulfotransferase activities has been linked to catecholamine toxicity, adverse drug reactions, drug therapy failure, and cancer susceptibility. In humans, there are 4 SULT families (SULT1, SULT2, SULT4 and SULT6). The SULT4 family comprises a single member SULT4A1, which has been referred to as a 'sulfotransferase-like protein' because it retains many of the features of the other SULTs but does not appear to be catalytically active. Nevertheless, recent SULT4A1 knockout studies in mice show a severe phenotype indicative of its biological importance. All human sulfotransferases have a dimerisation motif that regulates enzyme activity as well as protein stability. The formation of heterodimers provides an additional mechanism by which a cell can regulate sulfotransferase function. This will be demonstrated with several human sulfotransferase examples.

SULT1A3, which has only emerged since the great apes separated from other species, is required for neurotransmitter metabolism in several organs such as the GI tract and the brain. SULT1A3 efficiently metabolises dopamine and can influence its toxicity in neuronal cells *in vitro*<sup>1</sup>. The gene for the protein resides in a region of chromosomal instability so multiple copies can be demonstrated in humans. Importantly, there is an association between copy number variation and risk of developing neurodegenerative diseases such as Alzheimer's and early onset Parkinson's<sup>2</sup>. Our more recent data show that SULT4A1 is an important regulator of SULT1A1 and SULT1A3 by heterodimerisation that targets the proteins for degradation via autophagy. This finding may explain the severe phenotypes reported in SULT4A1 knockout animals.

1. Sidharthan et al JBC 288: 34364074, 2013.
2. Butcher et al. Pharmacogenomics J. (in press: doi: 10.1038/tpj.2017).

**112 Preclinical models to understand the risks of single and multiple concurrent medicines in old age**

John Mach<sup>1,2,3</sup>, Caitlin Logan<sup>1,3</sup>, Doug Drak<sup>1,3</sup>, Gizem Gemikonakli<sup>1,3</sup>, Swathi Ekambareshwar<sup>1,3</sup>, Jennifer Debenham<sup>1,3</sup>, Alice E Kane<sup>3,4</sup>, Susan Howlett<sup>4</sup>, Rafael de Cabo<sup>5</sup>, David G Le Couteur<sup>3,6</sup> & Sarah N Hilmer<sup>1,2,3</sup>, <sup>1</sup>Kolling Institute, Sydney, NSW  
<sup>2</sup>Royal North Shore Hosp, Sydney, NSW, <sup>3</sup>University of Sydney, Sydney, NSW, <sup>4</sup>Dalhousie University, Halifax, Canada, <sup>5</sup>National Institute on Aging, National Institute of Health, Maryland, USA, <sup>6</sup>Concord Hospital, Sydney, NSW

**Introduction:** Chronic medication use is common in older people. Older people, particularly those with polypharmacy (use  $\geq 5$  drugs) for multi-morbidity, are rarely included in clinical trials to determine efficacy and safety. Observational studies indicate polypharmacy and increasing Drug Burden Index (DBI: measures total anticholinergic and sedative medication exposure) are associated with impaired physical function in older people. Preclinical models of clinically relevant drug exposures in ageing would be useful to screen for adverse geriatric outcomes prior to marketing.

**Aim:** To develop a preclinical mouse model to determine whether chronic use of therapeutic drugs (monotherapy or polypharmacy) and/or increasing DBI exposure impair translatable functional outcomes in ageing.

**Methods:** From 12 months of age, male C57BL/6 mice were fed control diet or feed/water containing therapeutic doses of study drug(s). We tested regimens of five drugs that had Zero DBI (simvastatin, metoprolol, omeprazole, paracetamol, irbesartan), Low DBI (simvastatin, metoprolol, omeprazole, paracetamol, citalopram), High DBI (simvastatin, metoprolol, oxybutynin, oxycodone, citalopram) and single drugs from the High DBI regimen as monotherapy. Functional tests are performed every 3 months throughout life. Power calculations estimate that a sample size of 10-12 per group is required to detect changes in functional measures with treatment.

**Results:** For the subgroup of animals with data currently available after 6 months of treatment (age 15 and 18 months), compared to control, measures of spontaneous activity in the open field (distance and midzone entries), grip strength (wire hang), nesting scores and frailty score were reduced in the Low DBI, High DBI and citalopram groups ( $n=25-40$ ,  $p<0.05$ ). Compared to control, muscle endurance (rotarod) was significantly reduced in Low DBI and citalopram after 6 months of treatment ( $n=25-40$ ,  $p<0.05$ ).

**Discussion:** We have developed a preclinical model that can detect impaired functional outcomes following chronic treatment with polypharmacy regimens or monotherapy in ageing mice. These methods can be applied to determine and understand mechanisms and reversibility of the risks of medicines to global health outcomes in old age.

**113 Application of pharmacometric modelling for studying drug effects**

Carl M Kirkpatrick, Centre for Medicine Use and Safety, Monash University, Melbourne, VIC

What was once a nicety in drug development and at times considered an “academic” practice, the application of quantitative clinical pharmacology (pharmacometrics) has now become a fundamental in the armamentarium of pharmaceutical industry for the development of a medicine. Indeed, the application of pharmacometrics can now be witnessed from the very early stages of drug development through to post-marketing surveillance of a new medicine. This presentation highlights some of the pharmacometric approaches across in-vitro, pre-clinical and clinical stages of drug development to enhance drug development programs. In particular, how this approach is utilised to make key go/no go decisions and posology.

**114 Novel approaches in pharmacoepidemiological studies to communicate benefits and risks of medicines**

Danijela Gnjidic, Faculty of Pharmacy, University of Sydney, Sydney, NSW, Australia

**Introduction:** Assessing outcomes from medicines in people with multi-morbidity, polypharmacy and dementia is difficult as measures of clinical significance are rarely employed in clinical trials and applying the clinical trial evidence to 'real-world patients' with drug-drug, and disease-drug interactions is often challenging.

**Methods:** Recent efforts have been focused on employing novel pharmaco-epidemiologic methods to tackle the complex systems and networks that drive medication utilisation.

**Results:** In our study of community-dwelling men, using multi-state modelling method, we found that increasing medication burden was associated with transition to frailty states, namely from robust to frail state and subsequent increased risk of mortality in older people. Moreover, efforts have been made to quantify complex patterns of multimorbidity and polypharmacy in older adults using novel analysis such as Association Rule and Frequent-set analysis. In our study, using the Association Rule methodology we found several morbidity clusters. In relation to polypharmacy exposure, Frequent-set analysis showed that medication combinations differed according to geriatric syndrome status.

**Discussion:** Pharmacoepidemiology and pharmacovigilance data on medication utilisation and drug safety has a major influence on prescribing for older people.

**115 Pharmacoepidemiological studies to inform medication safety in older adults with chronic diseases and dementia**

Simon Bell, Centre for Medicine Use and Safety, Monash University, Melbourne, VIC, Australia

Randomised controlled trials (RCTs) are the 'gold standard' for investigating medicine efficacy but often exclude vulnerable population groups such as people with dementia, frailty and multimorbidity. Recent advances in the availability of electronic medical records, development of clinical registries and administrative claims data offer the potential to better understand and optimise medicine use in these vulnerable population groups. Observational studies conducted using these data sources are useful for detecting longer-term health outcomes and rare adverse events not able to be detected in RCTs. International consensus research priorities generated at the recent Optimising Geriatric Pharmacotherapy through Pharmacoepidemiology Network (OPPEN) in Stockholm will be presented. These priorities will be summarised under the themes of quality of medication use, vulnerable patient groups; multimorbidity and polypharmacy, person-centred practice and research, deprescribing, methodologies, variability in medication use, and national and international comparative research. Australian and international examples will be presented to demonstrate how observational studies can help improve the limited evidence base to inform prescribing for vulnerable population groups. Results of this pharmacoepidemiological research will assist clinicians better understand the benefits and risks of strict adherence to disease-specific clinical practice guidelines in people with dementia, frailty and multimorbidity.

**116 Changing guideline recommendations on the pharmacological management of back pain**

Christine Lin, Musculoskeletal Health Sydney, Sydney School of Public Health, The University of Sydney, Sydney, NSW, Australia

**Introduction:** Low back pain is a prevalent condition that causes the highest disease burden globally in terms of disability. Sciatica is a severe form of back pain that is characterised by radiating leg pain caused by lumbar nerve root compromise. To treat acute low back pain, the drug paracetamol has been universally endorsed by international clinical guidelines as a first line treatment, while the drug pregabalin is recommended for neuropathic pain conditions and commonly used to treat sciatica. However, there has been no direct evidence on the efficacy and safety of paracetamol or pregabalin in low back pain or sciatica.

**Aims:** To investigate the efficacy and safety of paracetamol in patients with acute low back pain and pregabalin in patients with sciatica.

**Methods:** Two double-blinded, randomised controlled trials were conducted. In the PACE Study, 1652 patients with acute low back pain were randomised to receive either paracetamol or placebo for up to 4 weeks and followed up at regular time points for 3 months. The primary outcome was time to recovery from pain, and secondary outcomes included pain intensity and disability. We also collected safety outcomes. In the PRECISE Study, 209 patients with sciatica were randomised to receive either pregabalin or placebo for up to 8 weeks and followed up at regular time points for 1 year. The primary outcome was leg pain intensity measured at 8 weeks. Secondary outcomes included pain at 1 year and disability at 8 weeks and 1 year. We also collected safety outcomes.

**Results:** In PACE, there was no difference in the time to recovery between those who took paracetamol or placebo, and no difference in all secondary outcomes and adverse events. In PRECISE, there was no difference in leg pain intensity at 8 weeks between those who took pregabalin or placebo, and no difference in all secondary outcomes at all time points. More people in the pregabalin group reported an adverse event ( $n = 68$  versus 43 in the placebo group,  $p = 0.002$ ); the most common adverse event was dizziness.

**Discussion:** Paracetamol is no more effective than placebo for acute low back pain. Pregabalin is no more effective than placebo for sciatica and is associated with more adverse events. These findings challenge the guideline recommendations supporting their use.

**117 Introducing a large-scale research project for undergraduate students**

Susan L Rowland, Institute for Teaching and Learning Innovation and School of Chemistry and Molecular Biosciences, The University of Queensland, St Lucia, QLD, Australia

The idea of conducting a research project with hundreds of undergraduate student researchers is both exciting and challenging for the implementers. We recently completed an OLT-funded project in which we worked with multiple educators around Australia to develop, deliver, and evaluate large-scale undergraduate research projects (LUREs) in their science and health-related classes.

After the implementations we spoke to the staff about their work, and about the things that both supported and challenged their endeavours. The current literature in this area focuses on the academic experience of implementing a LURE. We spoke with academics, but we also expanded our circle of enquiry by speaking to the laboratory technicians, the para-academics, and teaching assistants who were involved in the projects. This is the first study in which these staff members are given a voice as implementers of LUREs.

Our results gave us some surprising insights into what makes a LURE work, and the differences in challenges and pay-offs for the various implementer groups. In this talk I will share our findings, which will be of interest to academics, administrators, teaching assistants, and support staff who have a stake in LUREs.

**118 Peer assessment to develop critical analysis and self-reflection in large undergraduate cohorts**

Rosa C McCarty, Michael J Lew<sup>1</sup> Department of Pharmacology & Therapeutics, The University of Melbourne<sup>1</sup>, Melbourne, Victoria, Australia

**Introduction:** To be able to critically evaluate the work of others, and to objectively assess the quality of one's own work is an expectation of students who have completed undergraduate study. Peer assessment is a foundational skill for many types of careers. It is routinely used by scientists, clinicians, academics and non-academics alike. Peer assessment offers an opportunity for students to develop those skills, and in the process, encourages life-long learning, examination and reflection. Although many educators recognise the advantages of peer assessment, its implementation is often challenging, even to the extent of being thought impractical for undergraduate classes with large to very large enrolments, coupled with concerns regarding the reliability of the marking process.

**Aims:** To deliver an authentic learning experience through the use of peer assessment in large cohorts. Data will be collated to evaluate the reliability of results, and student perceptions of the peer assessment process.

**Methods:** A variety of different types of written assignments are applicable to the following method. Students submit de-identified assignments electronically through the university online subject management tool. Using a custom designed software program (note other commercially available programs are available), students receive via email their own assignment and five randomly assigned assignments from their peers, with a carefully designed marking guide and instructions. On completion of the process students were encouraged to provide feedback on the process via survey. We have also performed comparisons between peer marks and academic or expert markers, and between peer marks and self-assessment.

**Results:** We have implemented peer assessment over several years to thousands of undergraduate students, to a class size of up to 470. The assessment of work by peers, using the median of scores from five students, ensure reliability and robustness of marks. There is a strong correlation between peer marks and expert marking. To date, survey results suggest that students find the peer assessment process challenging but report positively on the learning process.

**Discussion:** This presentation will explore our experience of the merits of peer assessment. This form of assessment driven learning is a reliable and relevant pedagogical tool, applicable to small and large cohorts.

**119 Development of interprofessional communication skills for interprofessional collaboration**

Karen Luetsch, School of Pharmacy, The University of Queensland, Brisbane

Interprofessional collaboration in health care results in better outcomes for the people cared for as well as in increased satisfaction by health carers. Successful communication between health care professionals promotes collaboration. This presentation will draw on theory, research and experience in exploring the prerequisites, antecedents and environments promoting effective communication between health professionals and how to guide the development of communication skills of students. Most education in health care focuses on task orientated communication, using structured frameworks and processes to share information, avoid risk, increase safety and confirm responsibilities and actions. While this transmission of messages and information is employed successfully in critical situations, it has limitations when large interprofessional teams with fluctuating membership communicate over extended periods in the care of people with complex illnesses. Creating a common sense of purpose and shared meaning via communication and an understanding of each other's roles and strengths will enable health professionals and students to work together for the benefit of people they care for in an increasingly complex system. Strategies to achieve these in stages over a health professional's career will be introduced and discussed.

**120 Student perspectives on peer assessment, feedback and team work**

Jayden Kelly<sup>1</sup>, Mohammadali Taher<sup>1</sup>, School of Rural Health<sup>1</sup>, Department of Medicine, Monash University, Melbourne, Victoria, Australia.

Students are one of the primary stakeholders in any educational system, and their performance and success are directly affected by the administrations' decisions. This is particularly true in regards to the types of teaching methods implemented and the modes of content delivery. For instance, despite the ample evidence in favour of interactive teaching, universities often continue to opt for didactic methods. Often the decision is made because interactive teaching methods require more time and resources; ultimately resulting in the sacrifice of course content quantity. This perpetuation of the classical teaching model may also be reduced to the old adage; it is often hard to break old habits.

For the past three years, The School of Rural Health at Monash University has adopted the Flipped classroom teaching method for their MBBS post-graduate course. Flipped classroom is a reversal of traditional teaching methods, where students learn new material at home, through recorded lectures or reading textbooks, and spend class time applying their knowledge as they interact with their teachers and peers.

This talk will be a reflection on our experience of the flipped classroom model, as part of Monash MBBS course, and how it impacted our learning and interactions with our peers.

**121 Quantification of metformin in human serum by hydrophilic interaction liquid chromatography - Mass spectrometry**

Ahmed M. Abdalla<sup>1,2</sup>, Geoffrey K Isbister<sup>3</sup> and Michael S. Roberts<sup>1,4</sup>, <sup>1</sup>School of Pharmacy & Medical Sciences, University of SA, Basil Hetzel Institute for Translational Health Research, Adelaide, SA, <sup>2</sup>Pharmaceutical Chemistry Dept, Helwan University, Cairo, Egypt, <sup>3</sup>Clinical Toxicology Research Group, University of Newcastle, Newcastle, NSW, <sup>4</sup>Therapeutics Research Centre, Diamantina Institute, University of Qld, Translation Research Institute, Brisbane, Qld, Australia

**Introduction:** Metformin is widely used to treat diabetes mellitus type II and obesity.

Large metformin ingestion can cause severe and even fatal metabolic acidosis with hyperlactatemia. Hydrophilic interaction liquid chromatography (HILIC) is increasingly being used to quantify polar solutes, which traditionally have a low retention and poor separation on conventional reversed phase HPLC. Consequently, although most current metformin HPLC – tandem mass spectrometry (MSMS) methods involve a complex sample procedure.

**Aims:** Here, we used HILIC – ESI MSMS to quantify metformin in serum of patients who had overdosed on metformin.

**Methods:** The HILIC, coupled to a tandem mass spectrometer, was used to analyse serum metformin samples injected on to a Kinetex Polar C<sub>18</sub> 2.6 µm HILIC (Phenomenex) 50 X 2.1 mm HILIC column after simple protein precipitation and centrifugation. Chromatographic separation was achieved using a gradient flow of (10mM Ammonium Acetate) and (10mM Ammonium Acetate in 95:5 Acetonitrile: Water). Pregabalin was used as the internal standard.

**Results:** The HILIC – MSMS method for serum metformin was a robust, reproducible and easy to use assay. It had a LOQ of 3.5 µg/mL and the following variabilities for the concentrations of 6.25, 20 and 40 µg/mL: intra-day 4.4, 5.6, and 4.5%; Inter-day: 3.2, 5.1 and 3.9%; and recovery: 98.4, 94.6 and 97.2%. MS-MS multiple reaction monitoring decreased matrix interference and enhanced the specificity of the assay for metformin. Figure 1 shows an example of one patient's metformin serum concentration versus time profile after an overdose and was accompanied by a severe metabolic acidosis. It is evident the peak metformin serum concentration of 292µg/mL at 8h post-ingestion is very high compared to a typical value of 1.78 µg/mL seen after 2g extended release metformin in normal patients.<sup>1</sup>

**Discussion:** HILIC chromatography is provided to be an effective method for analysing metformin in serum.

<sup>1</sup> Timmins et al. Clin. Pharmacokin. 44, 721–729, 2005

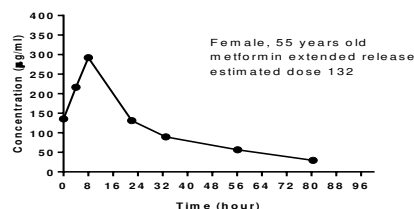

**122 ORAI1 calcium channels in cell death during mammary gland involution**

Felicity M Davis, Pharmacy Australia Centre of Excellence and Mater Research Institute, The University of Queensland1, Brisbane, QLD, Australia

**Introduction:** The nourishment of neonates by nursing is a defining characteristic of all mammals. Yet a mechanistic understanding of how mature luminal and myoepithelial cells in the breast perform their most primitive physiological functions (i.e. the production and expulsion of milk during lactation) has remained largely unexplored. We previously demonstrated that the store-operated Ca<sup>2+</sup> channel subunit Orai1 is required for optimal Ca<sup>2+</sup> transport into milk and for milk ejection (Davis et al., 2015 PNAS). Indeed, mammary glands from lactating Orai1-null mice exhibit pronounced milk stasis, owing to impaired Ca<sup>2+</sup>-dependent myoepithelial cell contractility in response to oxytocin.

**Aims:** As milk stasis is a trigger for post-lactational cell death (involution) in the mammary gland, our work is now seeking to investigate whether ORAI1 channels also play an essential role in decoding involution signals in the postpartum breast.

**Methods:** Mammary gland involution is marked by a dramatic switch in signal transducer and activator of transcription (STAT) signaling. Whilst STAT5 activation is required for the differentiation of luminal secretory cells during pregnancy and lactation, STAT3 activation drives cell death and remodeling during involution. STAT3 and STAT5 activation are examined using immunoblotting, immunofluorescence and immunohistochemistry on wildtype and transgenic mouse tissue as well as mouse mammary epithelial cell lines in response to lactogenic hormones and involution stimuli.

**Results:** Preliminary analyses demonstrate that luminal epithelial cells from Orai1-null mice remarkably express both phospho-STAT5 and phospho-STAT3, and are thus suspended in state resembling both lactation and involution.

**Discussion:** Ongoing studies in our laboratory using lineage-specific conditional knockout mice will provide important insights into the roles for ORAI1 calcium channels in the post-lactational mammary epithelial cell death cascade. An appreciation of the signaling pathways regulating cell death in the mammary epithelium under physiological conditions will provide valuable insights into cell death and cell death resistance in breast cancer, and how this enormous cell death cascade could be exploited therapeutically.

**123 Pre-clinical pharmacokinetic development of the hypoxia-activated cytotoxin SN36506**

Matthew Bull<sup>1,2</sup>, Chris Guise<sup>1,2</sup>, Maria Abbattista<sup>1,2</sup>, Amir Ashoorzadeh<sup>1,2</sup>, Jan Theys<sup>3</sup>, Ludwig Dubois<sup>3</sup>, Philippe Lambin<sup>3</sup>, Jeff Smaill<sup>1,2</sup> and Adam Patterson<sup>1,2</sup>, <sup>1</sup>Auckland Cancer Society Research Centre, University of Auckland, Auckland, New Zealand, <sup>2</sup>Maurice Wilkins Centre for Molecular Biodiscovery, School of Biological Sciences, University of Auckland, Auckland, New Zealand, <sup>3</sup>MAASTRO, GROW, MUMC, Maastricht, The Netherlands

**Introduction:** Cytotoxic prodrugs designed to target the hypoxic tumour microenvironment have the potential to selectively eliminate cancer cells whilst minimising normal tissue toxicities. Here we report the pre-clinical evaluation of the pharmacokinetics of SN36506, a novel second generation hypoxia-activated DNA crosslinking agent.

**Aims:** The primary aim of this research was to assess the pharmacokinetics and metabolism of SN36506, with a view to development towards clinical trial.

**Methods:** Plasma stability was assessed under physiological conditions and plasma protein binding was evaluated using microdialysis. Metabolic stability was determined in preparations of liver microsomes and under anoxic conditions in cancer cells. Metabolite profiles were obtained from microsomal incubations and in vivo plasma samples from dosed NIH-III mice. An LCMSMS method was developed and validated for the quantitation of SN36506. The pharmacokinetic profile of SN36506 was evaluated in tumour-free NIH-III mice using three routes of administration. Efficacy was evaluated in vivo in tumour growth delay models against triple-negative breast cancer xenografts.

**Results:** Under severe hypoxic conditions metabolism by human neoplastic cell lines in vitro produced the major cytotoxic amine metabolite (SN36506M). SN36506 exhibited low human plasma protein binding (11.90 ± 10.71%) and high human plasma stability (99.35 ± 3.08% at 37°C, 30 min). In microsomal incubations SN36506 was primarily metabolised via N-dealkylation of the mustard arm. SN36506 was 47% orally bioavailable and, at 1.17 mmol/kg ip, half-life was 0.54 hr and AUC was 261.4 hr.µmol/L. N-dealkylation products were also observed. Monotherapy SN36506 (1.17 mmol/kg ip) resulted in significant tumour growth delay in the xenograft cancer models.

**Discussion:** The pre-clinical pharmacokinetics of SN36506 represents an improvement in hypoxia-activated prodrug design in comparison to first generation phase II candidate prodrugs and further clinical development of SN36506 is being pursued.

**124 A new high-throughput approach for investigating GPCR internalisation in real-time**

Simon R Foster<sup>1</sup>, Alexander S Hauser<sup>1</sup>, David E Gloriam<sup>1</sup> & Hans Bräuner-Osborne<sup>1</sup>, Department of Pharmacology and Drug Design, University of Copenhagen<sup>1</sup>, Copenhagen, Denmark

**Introduction:** Endocytic trafficking represents an important mechanism for G protein-coupled receptor (GPCR) regulation, serving to internalise the receptors and attenuate G protein-dependent signalling. In addition, accumulating evidence suggests that GPCRs can signal independently of G proteins and from intracellular compartments. In this context, receptor internalisation has attracted renewed interest within the GPCR field.

**Aims:** To develop and optimise a real-time time-resolved fluorescence resonance energy transfer (TR-FRET) assay to investigate GPCR internalisation.

**Methods:** SNAP-tagged GPCRs were stably expressed in an inducible HEK293 cell line (T-REx™-293 Cell Line). Cell-surface receptors were irreversibly labelled with a terbium cryptate derivative (Cisbio Bioassays, Codolet, France) and stimulated with agonist in the presence of a cell-impermeable energy acceptor, and TR-FRET was recorded using an Envision 2104 Multilabel Reader (Perkin-Elmer, USA). The resulting donor:acceptor emission ratio was used to assess internalisation over time.

**Results:** Agonist stimulation evoked robust receptor internalisation, as shown for GLP-1 on SNAP-GLP1R expressing cells. The response was reproducible and concentration-dependent ( $EC_{50}$  26 nmol/L). Conducted in 384-well format, the assay had a  $Z'$  value of 0.7, making it ideally suited for high throughput screening efforts.

**Discussion:** We have now applied this technique to study internalisation of numerous class A, B and C receptors, including the  $\beta_2$ -adrenoceptor, GLP1R and GPRC6A (Jacobsen SE et al, 2017; Roed SN et al, 2014) and a variety of orphan receptors. This assay is a sensitive, easily-quantified, unbiased and real-time readout of receptor movement, that can be used for investigating the kinetics of ligand-dependent and constitutive internalisation.

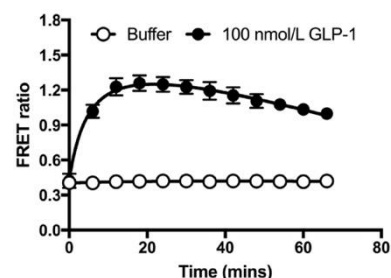

Jacobsen SE et al (2017) J Biol Chem 292:6910-6926.

Roed SN et al (2014) Mol Cell Endocrinol 382:938-49.

**125 CSKSSDYQC peptide conjugated N-trimethyl chitosan enhance the oral bioavailability of gemcitabine by targeting goblet cells**

Guanyu Chen<sup>1</sup>, Darren Svirskisa, Weiyue Lub, Man Ying<sup>2</sup>, Yuan Huang<sup>3</sup>, Jingyuan Wen<sup>1</sup>, <sup>1</sup>School of Pharmacy, FMHS, University of Auckland, New Zealand, <sup>2</sup>Department of Pharmaceutics, School of Pharmacy, Fudan University, China, <sup>3</sup>Key Laboratory of Drug Targeting, West China School of Pharmacy, Sichuan University, China

**Introduction:** Gemcitabine is a nucleoside analogue effective against a number of cancers. However, its highly hydrophilic nature and poor permeability over intestinal epithelium results in low oral bioavailability while the short half-life leads to frequent dosing requirements. This study reports the synthesis, *in-vitro*, *ex-vivo* and *in-vivo* evaluation of trimethyl chitosan (TMC) conjugated with CSKSSDYQC (CSK) peptide to enhance the oral bioavailability of gemcitabine due to the ability to target intestinal goblet cells and promote cellular uptake.

**Aims:** To enhance gemcitabine oral bioavailability via goblet cell targeting.

**Methods:** Gemcitabine loaded TMC-CSK nanoparticle (NP) was fabricated via an ionic gelation method. The TMC polymer was synthesized by using a new two-step methylation method. The physical and chemical properties of the delivery systems were determined including particles size, zeta potential, entrapment efficiency and *in-vitro* drug release study. *In vitro* cellular uptake mechanism was investigated using co-cultured Caco-2 and HT29-MTX-E12 cell models. Finally, the pharmacokinetic parameters were determined using a Sprague-Dawley (SD) rat model and the tumour growth rate associated with the drug solution and the drug loaded NPs were investigated using a BALB/c nude mouse model.

**Results:** Drug loaded TMC-CSK delivery system provides a particle size of  $173.6 \pm 6.8$  nm, zeta potential of  $+18.5 \pm 0.2$  mV and entrapment efficiency of  $66.4 \pm 0.1\%$ , with the ability to release drug in a sustained manner. The cellular uptake was time- and concentration- dependent associated with clathrin and caveolae mediated endocytosis.

In pharmacokinetic studies, drug loaded TMC-CSK NPs showed an improved oral bioavailability of 60.14% compared to gemcitabine solution of 9.86%. In pharmacodynamics study has shown the drug loaded TMC-CSK NPs reduced the tumour growth rate in a BALB/c nude mouse model, with a 5.1-fold reduction compare to the control group.

**126 Nicotine-loaded chitosan nanoparticulate dry powder inhaler formulation for its activity**

N. Islam<sup>1</sup>, H. Wang<sup>1</sup>, J. Holgate<sup>2</sup>, S. Bartlett<sup>2</sup>, G. George<sup>3</sup>, <sup>1</sup>School of Clinical Sciences, Queensland University of Technology (QUT), Brisbane, QLD, <sup>2</sup>The QIMR Berghofer Medical Research Institute, Brisbane, QLD, <sup>3</sup>Science and Engineering Faculty, QUT

**Introduction:** Currently available dosage forms for the management of nicotine addiction are inefficient due to the substantial required dose or serious withdrawal symptoms. Inhalation is an efficient therapy method which delivers drugs directly into deep lungs for systemic effect in short period of time.

**Aim:** To develop nicotine nanoparticles as dry powder inhaler (DPI) formulation for behaviour test in mice.

**Methods:** Nicotine hydrogen tartrate (NHT)-loaded chitosan nanoparticles were prepared using a W/O emulsion method and characterized using SEM, TEM, Mastersizer. Using a twin stage impinger (TSI) the aerosolization properties were determined. In vivo locomotor test (n=8 each group) in the photocell activity chambers was applied to evaluate the efficiency of nicotine nanoparticles compared with NHT by injection, and saline injection was as control.

**Results and Discussion:** The prepared nicotine loaded chitosan nanoparticles were produced FPF of 30.6%, which is comparable to currently available DPI products. The drug rapidly released from the nanoparticles initially due to the rapid dissolution of surface adhered/entrapped drug, and gradually became slower because of the penetration of the PBS release medium into the nanoparticles and dissolution of the entrapped drug. The maximum cumulative release was found to be around 70% in 7 days. A dose-related response to nicotine was observed from locomotor activity test from injection, with a longest travelled distance seen at the dose of 0.5 mg/kg on NHT and nicotine nanoparticles, in comparison to saline control groups (P<0.05), indicating the greatest stimulation was produced at such dose. The higher dose caused hypoactive effects for mice confirmed by travelling a shorter total distance.

**Conclusion:** The prepared nicotine-loaded chitosan nanoparticles can achieve prolonged release of nicotine from nanoparticulate DPI formulations. The outcomes from mice locomotor activity test confirmed that the novel nicotine nanoparticles were active and comparable to injectable dosage form.

**127 Monitoring NanoBRET ligand binding to endogenous adenosine A2B receptors**

Elizabeth KM Johnstone<sup>1,2</sup>, Kevin DG Pflieger<sup>1,2,3</sup>, Carl W White<sup>1,2,4</sup>, <sup>1</sup>Mol Endocrinol and Pharmacol, Harry Perkins Inst of Med Res, Nedlands, WA, <sup>2</sup>Centre for Med Res, Univ of Western Australia, Crawley, WA, <sup>3</sup>Dimerix Ltd, Nedlands, WA, <sup>4</sup>Cell Signaling Res Group, Univ of Nottingham Med School, Nottingham, UK

**Introduction:** Bioluminescence resonance energy transfer (BRET) is a versatile biophysical tool, enabling monitoring of many facets of G protein-coupled receptor (GPCR) function, including ligand binding and signalling, as well as trafficking and internalisation. However, the requirement for exogenous expression of a luciferase-tagged fusion protein has the potential to impact on the physiological relevance of the assays. Recently, we published the first study showing that through the use of CRISPR/Cas9-engineering, BRET could be used to monitor proximity to endogenous proteins, including GPCR-mediated  $\beta$ -arrestin recruitment, receptor internalisation and trafficking, as well as heteromerisation.

**Aims:** This study aimed to further investigate the potential of using BRET to monitor fluorescent ligand binding to endogenous GPCRs.

**Methods:** CRISPR/Cas9-mediated homology-directed repair was used to insert Nluc into the *ADORA2B* genomic locus in HEK293 cells, resulting in N-terminally tagged A<sub>2B</sub> receptors. NanoBRET ligand binding assays (Stoddart et al, 2015) were then used to assess ligand binding.

**Results:** Functionality of the CRISPR/Cas9 engineered A<sub>2B</sub> receptors was confirmed in cAMP assays. The engineered cells were then successfully used to assess binding of several different fluorescent or unlabelled ligands in kinetic, saturation and competition NanoBRET ligand binding assays. Comparisons with cells expressing exogenously expressing Nluc/A<sub>2B</sub> receptors were also made.

**Discussion:** Using CRISPR/Cas9-mediated genome engineering, we have shown that NanoBRET can be used to observe fluorescent ligand binding at GPCRs under endogenous promotion.

Stoddart et al. (2015) Nat Methods 12: 661-663.

White et al. (2017) Sci Reports 7: 3187.

**128 Dual action calcium sensing receptor modulator, calhex231, unmasks novel mode-switching mechanism**

K.J. Gregory<sup>1</sup>, I Kufareva<sup>2</sup>, E Khajehali<sup>1</sup>, A.N. Keller<sup>1</sup>, H. Mun<sup>3</sup>, A. Panwar<sup>1</sup>, A.P. Townley<sup>1</sup>, R.S. Mason<sup>3</sup>, B. Capuano<sup>1</sup>, A.D. Conigrave<sup>3</sup>, A. Christopoulos<sup>1</sup>, K. Leach<sup>1</sup>, <sup>1</sup>Drug Discov Biol and Dept Pharmacol, MIPS, Monash Univ, Parkville, VIC, Australia, <sup>2</sup>UCSD, La Jolla, CA, USA, <sup>3</sup>Uni Syd, Sydney, NSW, Australia

**Introduction:** Negative allosteric modulators (NAMs) of the human calcium sensing receptor (CaSR) have failed to show efficacy in human osteoporosis clinical trials but there is now significant interest in repurposing these drugs for hypocalcaemic disorders and inflammatory lung diseases. However, little is known about how CaSR NAMs inhibit the response to endogenous activators. An improved understanding of CaSR negative allosteric modulation may afford the opportunity to develop therapeutically superior CaSR-targeting drugs.

**Aims:** We aimed to elucidate the mechanistic and structural basis of allosteric modulation mediated by the previously reported CaSR NAM, calhex231, in comparison with the well-validated NAM, NPS-2143.

**Methods:** We used high-throughput signalling assays (intracellular Ca<sup>2+</sup> (iCa<sup>2+</sup>) mobilisation and IP1 accumulation) in recombinant cells stably expressing human CaSR (and mutants thereof) to rigorously quantify calhex231 pharmacology. To compare wild-type and mutant receptors we used one-way ANOVA with Dunnett's post-test (P<0.05). Interpretation of mutagenesis data was aided by docking to a CaSR homology model based on related metabotropic glutamate receptor x-ray structures. In addition, we assessed CaSR modulation of parathyroid hormone (PTH) release from primary human parathyroid cells.

**Results:** As expected, NPS-2143 behaved as a CaSR NAM, reducing the potency of, and maximal response to, extracellular Ca<sup>2+</sup> (Ca<sup>2+</sup><sub>o</sub>) in IP1 accumulation and iCa<sup>2+</sup> mobilisation assays. Surprisingly, calhex231 potentiated Ca<sup>2+</sup><sub>o</sub> potency in a concentration dependent manner between 0.1-1uM; however, at concentrations >3uM, calhex231 inhibited CaSR activity. These profiles were recapitulated when measuring PTH release from human parathyroid cells. Through site-directed mutagenesis in combination with computational modelling, we found that key residues within the common allosteric site significantly reduce calhex231 affinity and/or cooperativity.

**Discussion:** We find that calhex231 actually potentiates or inhibits the activity of multiple CaSR agonists depending on whether it occupies one or both protomers in a CaSR dimer. These findings reveal a novel mechanism of mode-switching at a Class C G protein-coupled receptor that has implications for drug discovery and potential clinical utility.

**129 Cardiomyocyte ErbB4 receptors are essential for cardiac hypertrophy and growth of neonatal mice, and contribute to maintenance of cardiac function in adult hearts**

Reichert ME<sup>1</sup>, Wang Z<sup>2</sup>, Thorn C<sup>3</sup>, Paravacini T<sup>4</sup>, Thomas WG<sup>1</sup>, <sup>1</sup>School of Biomedical Sciences, University of Queensland, St Lucia, QLD, <sup>2</sup>University of California, Davis, Davis CA, USA, <sup>3</sup>Department of Pharmacology, University of Oxford, Oxford, UK, <sup>4</sup>School of Medical Sciences, RMIT, Melbourne, VIC

**Introduction:** Activation of ErbB4 by neuregulin 1 (NRG1) promotes cardiomyocyte hypertrophy and proliferation in neonatal and adult mice, while application of NRG1 following myocardial infarction reduces scar size and improves function. Less is known about ErbB4 participation in physiological and pathophysiological cardiac hypertrophy.

**Aim:** Evaluate the role of cardiomyocyte ErbB4 in developmental, exercise-, and angiotensin-induced hypertrophy.

**Methods:** For adult studies, ErbB4 was deleted in αMHC-MerCreMer (cCre Tg<sup>+/+</sup>)/ErbB4 floxed (ErbB4<sup>ff</sup>) mice at ~2 months of age with 10 injections of Tamoxifen (20 mg/kg/day). Mice were aged for up to 8 months, exposed to Angiotensin II (Ang II, 1000ng/kg/min, 14 days) or exercised (twice daily swimming, 20 min/session increasing 10 min/day to 90 min followed by 7 days at 90 min/session). Neonates (ErbB4<sup>ff</sup> or ErbB4<sup>ww</sup>) received temporal vein injections of AAV9-ctNT-iCre (2.16x10<sup>11</sup> viral particles) at p1-2 and were culled at p6-7.

**Results:** Three months after deletion of ErbB4 in adult hearts, contractile function was reduced *in vivo* (echocardiography, 16%) and *ex vivo* (isolated-perfused, 33%), however deletion failed to modify heart size, survival for 8 months or hypertrophy in response to Ang II or exercise. In neonates, the presence of iCre mRNA in hearts confirmed virus infection, and suppression of ErbB4 in ErbB4<sup>ff</sup> mice was coincident with increased NRG1α, and reduced body and ventricular weights (Figure).

**Discussion:** ErbB4 is critical to cardiac hypertrophy and growth in neonatal mice, and maintains adult heart function.

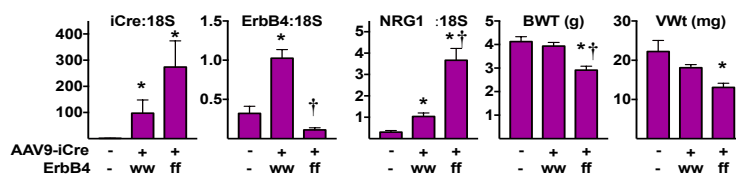

**Figure: Cardiomyocyte ErbB4 deletion in neonatal mice.** \*, p < 0.05 vs non-viral control; †, p < 0.05 vs ErbB4<sup>ww</sup> + AAV9-eGFP-iCre

### 130 Comparing the anti-fibrotic effects of emerging treatments: Serelaxin and the IRAP inhibitor, HFI-419 to a clinically-used ARB and ACE inhibitor in a high salt-induced mouse model of kidney disease.

Matthew Shen, Adithya Shastry, Yan Wang, Tracey A. Gaspari, Robert E. Widdop, Chrishan S. Samuel. Biomedicine Discovery Institute and Department of Pharmacology, Monash University, Clayton, VIC 3800, Australia.

**Introduction.** Fibrosis is a hallmark of chronic kidney diseases and its inability to resolve causes severe organ dysfunction and end-organ failure. The limited anti-fibrotic efficacy of current therapies suggests a need for alternative treatments.

**Aims.** To compare the anti-fibrotic effects of serelaxin (human recombinant relaxin; RLX) and HFI-419 to the AT1 receptor blocker, Candesartan cilexetil (CAND) or ACE inhibitor, Perindopril (PERIN) in a murine high salt (HS) diet-induced model of kidney disease.

**Methods.** 8-10 week male C57Bl/6J mice were subjected to 8-weeks of HS (5% NaCl) diet-induced renal injury. From weeks 5-8, sub-groups (n=4-8) were treated with either vehicle, RLX (0.5mg/kg/day), HFI-419 (0.72mg/kg/d), CAND (2mg/kg/day) or PERIN (4mg/kg/d). Each drug dose used had previously demonstrated anti-fibrotic efficacy in other experimental models. Mice maintained on a normal salt (NS) diet (0.5% NaCl) for 8-weeks were used as controls. Various measures of renal inflammation and fibrosis as well as plasma urea levels were evaluated.

**Results.** HS diet-fed mice were associated with significantly increased renal inflammation, TGF- $\beta$ 1 expression levels, myofibroblast differentiation, glomerulosclerosis, interstitial fibrosis, TIMP-1 levels and vascular rarefaction (determined by morphometry of Masson's trichrome- or immunohistochemically-stained sections and/or Western blotting), total kidney collagen concentration (hydroxyproline analysis) and plasma urea compared to that measured from NS diet-fed counterparts (all  $P < 0.01$  vs NS group). RLX or HFI-419 significantly reduced most measures of HS-induced renal fibrosis and plasma urea levels back to that measured in mice fed the NS diet (all  $p < 0.05$  vs HS group). RLX or HFI-419 demonstrated similar, if not greater, anti-fibrotic effects compared to that offered by PERIN, but which also reduced blood pressure, body weight and worsened plasma urea levels at the dose used ( $p < 0.01$  vs HS group). CAND, however, did not demonstrate any marked anti-fibrotic effects in the model/organ studied.

**Discussion.** RLX or HFI-419 offers improved anti-fibrotic efficacy and renoprotection compared to CAND and safer anti-fibrotic efficacy compared to PERIN in the setting of HS-induced kidney damage.

### 131 Role of TRPC3 in endothelium-dependent vasodilation of rat mesenteric arteries

Sarah E Wright and Timothy V Murphy. Dept of Physiol, Sch of Med Sci, UNSW Sydney, Sydney NSW, Australia.

**Introduction.** Endothelium-dependent dilation (EDD) of arteries is an important auto-regulatory function of the microvasculature. Previous studies suggested a role for transient receptor potential canonical-3 channels (TRPC3) in EDD (Senadheera et al., 2012) using pyrazole-3, a TRPC3 blocker with poor selectivity (Schleifer et al., 2012).

**Aims.** The present study further examined the role of TRPC3 in both agonist and flow-stimulated EDD of arteries utilizing a new, more selective TRPC3 blocker, pyrazole-10 (PYR10; Schleifer et al., 2012).

**Methods.** Cumulative stimulus-response curves to ACh (1 nM/L - 10  $\mu$ M/L) or intra-luminal flow (0-20 $\mu$ L/min) were performed in isolated, pressurized (60 mmHg), phenylephrine-constricted rat mesenteric arteries. Data is presented as % maximum dilation from baseline.

**Results.** In control arteries, increasing flow caused dilation, with peak dilation observed at 14 $\mu$ L/min ( $17.2 \pm 3.2\%$ , n=6). The flow-mediated dilation (FMD) was not altered by inhibition of nitric oxide (NO) synthase and guanylate cyclase using a combination of L-NAME (100  $\mu$ M) and ODQ (10  $\mu$ M). In the presence of PYR10 (1  $\mu$ M), some FMD persisted at low flow rates (<10  $\mu$ L/min), but at flow  $\geq 12\mu$ L/min significant flow-induced constriction of vessels was observed (max constriction  $-21.8 \pm 10.5\%$   $P \leq 0.05$ , n=4). ACh caused a concentration-dependent dilation of mesenteric arteries ( $pEC_{50} = 7.63 \pm 0.09$ , max  $95.1 \pm 2.6\%$ , n = 4). The ACh-induced dilation was inhibited by PYR10 (max  $51.0 \pm 1.5\%$ ,  $P < 0.05$ , n = 4). The combination of L-NAME, ODQ and PYR10 further reduced ACh-induced dilation (max  $10.0 \pm 1.1\%$ ,  $P < 0.05$ , n = 4). PYR10 did not alter phenylephrine-induced vasoconstriction of the arteries.

**Discussion.** These studies support a role for TRPC3 in mediating both agonist- and flow-induced EDD of rat mesenteric arteries. TRPC3 appears to be coupled to non-NO-dependent signaling pathways, presumably involving endothelium-derived hyperpolarization of vascular smooth muscle.

Schleifer H, et al. (2012). Br J Pharmacol 167: 1712-1722.

Senadheera S, et al. (2012). Cardiovasc Res 95: 439-447.

**132 Targeting IRAP: A Novel Treatment to Stabilize Existing Abdominal Aortic Aneurysms**

Kaki Fan<sup>1</sup>, Robert Widdop<sup>1</sup>, Ekaterina Salimova<sup>2</sup>, Siew Yeen Chai<sup>3</sup> & Tracey Gaspari<sup>1</sup>. Dept of Pharmacol, Monash University<sup>1</sup>, Clayton, VIC, Australia; ARMI, Monash University<sup>2</sup>, Clayton, VIC, Australia; Dept of Physiol, Monash University<sup>3</sup>, Clayton, VIC, Australia.

**Introduction.** Abdominal aortic aneurysm (AAA) is a degenerative disease with no pharmacological treatment available to prevent progression or risk of rupture. Preliminary evidence from our laboratory indicated inhibition/deficiency of the enzyme, insulin regulated aminopeptidase (IRAP) prevented AAA formation in angiotensin (Ang) II-infused mice, indicating IRAP may be a novel target in treatment of AAA.

**Aim.** To determine if the IRAP inhibitor, HFI-419 can stabilize established AAA in Ang II-infused apolipoprotein E deficient (ApoE KO) mice.

**Methods.** 12 week old male ApoE KO mice were infused with Ang II (1000ng/kg/min) for 6 weeks to induce AAA. Once presence of established AAA was confirmed mice were randomized to receive either vehicle or HFI-419 (500ng/kg/min; s.c.) from weeks 2-6. Ultrasound imaging (to measure aortic diameter and area) and systolic blood pressure (SBP; tail cuff method) measurements were performed fortnightly to track AAA development and SBP changes

**Results.** Two-week infusion of Ang II induced aneurysm formation in >90% of all mice. Co-infusion of HFI-419 with Ang II significantly reduced aneurysm area and diameter in the absence of any effect on SBP. Immunohistochemistry analyses confirmed increased expression of IRAP in proximal aorta and AAA sections taken from Ang II infused mice whilst IRAP inhibition tended to reduce IRAP expression. HFI-419 treatment attenuated elastin degradation which was correlated with reduced matrix metalloproteinase (MMP)-9 and macrophage expression in AAA sections.

**Discussion.** Inhibition of IRAP significantly reduced progression of established AAA, although underlying protective mechanisms are still under investigation. This study highlights the potential of inhibiting IRAP as a novel therapy for treatment of AAA

**133 Inhibition of the transient receptor potential melastatin 7 (TRPM7) channel-kinase improves cardiac function in an ex vivo model of ischaemia/reperfusion injury**

Tamara M Paravicini, Owen L Woodman, School of Health and Biomedical Sciences, RMIT University, Melbourne VIC, Australia

**Introduction:** TRPM7 is a Mg<sup>2+</sup> and Ca<sup>2+</sup>-permeable channel that is critical for cellular growth and development. Importantly, the TRPM7 channel also contains an active kinase domain, making it unique amongst ion channels in the ability to both transport ions and directly activate intracellular signalling cascades. TRPM7-mediated Ca<sup>2+</sup> influx is increased in neuronal and renal ischaemia/reperfusion (I/R) injury, and inhibition of TRPM7 prevents cell death in these models of I/R injury. However, whether TRPM7 also contributes to myocardial I/R injury remains unknown.

**Aims:** To determine if TRPM7 inhibition can reduce myocardial I/R injury in an *ex vivo* model.

**Methods:** Hearts were isolated from adult male rats, perfused in the Langendorf mode at constant flow (10 mL/min), and subjected to 25 minutes of global no-flow ischaemia followed by 30 minutes of reperfusion. Hearts were treated with either vehicle (0.03% dimethyl sulfoxide) or the TRPM7 inhibitor NS8593 (3 µM) for 10 minutes prior to ischaemia and throughout reperfusion, or during reperfusion alone.

**Results:** In vehicle-treated hearts, the left ventricular developed pressure (LVDP) at the end of reperfusion was reduced by ~ 70% compared to the pre-ischaemic baseline. This was significantly improved by treatment with NS8593 (% pre-ischaemic baseline: NS8593 58.4±8.6% vs vehicle 28.3±3.3%, n=8-10, P<0.05). Similarly, TRPM7 inhibition improved both +dP/dt (% pre-ischaemic baseline: NS8593 48.1±7.7 vs vehicle 23.5±4.0, n=8-10, P<0.05) and -dP/dt (% pre-ischaemic baseline: NS8593 54.9±7.0 vs vehicle 30.6±5.1, n=8-10, P<0.05). NS8593 had no significant effect on heart rate during reperfusion. The beneficial effects of NS8593 on cardiac function were only evident if administered prior to ischaemia, as administration of NS8593 during reperfusion only did not significantly improve LVDP or +dP/dt compared to vehicle-treated hearts

**Discussion:** Pharmacological inhibition of TRPM7 with NS8593 improves ventricular function after ischaemia and reperfusion in isolated hearts if administered prior to ischaemia. This suggests that TRPM7 contributes to myocardial damage during I/R injury, and that the cardioprotection induced by NS8593 may involve activation of signalling pathways involved in cardiac preconditioning.

### 134 Functional regulation of bitter taste receptors (T2Rs) by $\beta$ 2-adrenergic and M2 muscarinic acetylcholine receptor

Jilai Zhao<sup>1</sup>, Conor J Bloxham<sup>1</sup>, Simon R Foster<sup>2</sup>, Brooke Purdue<sup>1</sup> & Walter G Thomas<sup>1</sup>, <sup>1</sup>School of Biomed Sci, Univ of Queensland, Brisbane, QLD, Australia, <sup>2</sup>Dept of Drug Design and Pharmacol, Univ of Copenhagen, Copenhagen, Denmark

**Introduction:** G protein-coupled receptors (GPCRs) are key mediators of cardiac physiology and targeted for therapeutics. The ectopic expression of bitter taste receptors (T2Rs) in heart was first reported by the Thomas Laboratory. Stimulation of T2R14 in human right atrial tissue with bitter ligands produces a dramatic cardiodepressant effect, but it is not known whether the actions of T2R14 are modulated by other GPCRs related to cardiac contractility, principally the adrenergic and muscarinic receptors.

**Aims:** To determine the effect of co-expressing and activating the  $\beta$ 2-adrenergic receptor and the M2 muscarinic receptor on the activation of the T2R14 bitter receptor.

**Methods:** AD293 cells were transfected with T2R14, chimeric G protein  $G\alpha_{16/gust44}$ , and the  $Ca^{2+}$  sensor GCaMP5. Ligand stimulated intracellular  $Ca^{2+}$  was measured by fluorescence imaging via an automated fluorometric plate reader. Fluorescently tagged T2Rs were used in confocal imaging studies, focusing on the expression and localisation of T2Rs.

**Results:** The co-expression of the  $\beta$ 2-adrenergic receptor significantly reduced T2R signalling in response to flufenamic acid (see figure). Conversely, an increase in T2R function was observed when co-expressed with the cardiac parasympathetic regulator, M2 muscarinic acetylcholine receptor. These changes did not involve alterations in the expression and cellular localisation of T2R14. Pre-treatment with adrenergic/muscarinic ligands did not affect subsequent activation of the T2R14.

**Discussion:** Co-expression of T2Rs with the adrenergic and muscarinic receptors alters their responsiveness and efficacy to bitter ligands, leading to consequent effects on cardiomyocyte contractility. Ongoing investigations are probing the mechanism involved.

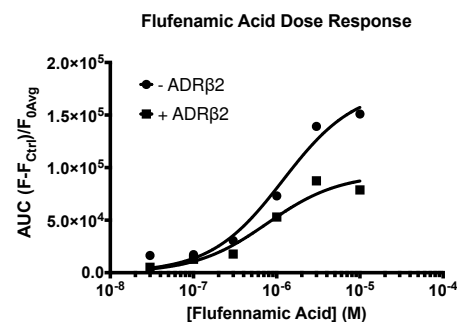

### 135 Defining the progression of diabetic cardiomyopathy in a mouse model of type 1 diabetes

Miles J De Blasio<sup>1,3</sup>, Nguyen Huynh<sup>1</sup>, Leslie Dubrana<sup>1</sup>, Darnel Prakoso<sup>1,3</sup>, Chengxue Qin<sup>1,4</sup>, Mitchel Tate<sup>1</sup>, Minh Deo<sup>1</sup>, Osezua Oseghale<sup>1</sup>, Helen Kiriazis<sup>2</sup>, Xiao-Jun Du<sup>2,5</sup>, Rebecca H Ritchie<sup>1,4,5</sup>, <sup>1</sup>Heart Failure Pharmacology; <sup>2</sup>Experimental Cardiology; Baker Heart and Diabetes Institute, Melbourne, VIC, <sup>3</sup> School of BioSciences; Department of Pharmacology and Therapeutics<sup>4</sup>; University of Melbourne, Parkville VIC, <sup>5</sup>Department of Medicine; Monash University, Clayton, VIC

**Introduction:** The incidence of diabetes is rapidly expanding and its association with increased risk of cardiovascular disease represents a major health issue worldwide. Hyperglycaemia is implicated as a central driver of responses seen in the diabetic heart such as hypertrophy, fibrosis and oxidative stress, together termed diabetic cardiomyopathy. The timing of onset of each response in the setting of diabetes has not been studied to date.

**Aims:** To determine the time-course of development of characteristics of diabetic cardiomyopathy in a mouse model of type 1 diabetes *in vivo*.

**Methods:** Diabetes was induced in 6-wk-old male FVB/N mice via streptozotocin (55mg/kg i.p. for 5 d; controls received citrate vehicle). After 2, 4, 8, 12 or 16-wks of untreated diabetes, left ventricular (LV) function via Doppler echocardiography was determined, prior to cull and subsequent measurement of markers of cardiomyocyte hypertrophy, LV collagen deposition, DNA fragmentation and markers of the hexosamine biosynthesis pathway (HBP).

**Results:** Blood glucose and HbA1c were elevated from 2-wks of diabetes. Relative to tibia length, LV and muscle weights were reduced from 8-wks, whereas liver and kidney weights were increased from 2 and 4-wks, respectively. LV diastolic function worsened with diabetes progression demonstrated by decreased E/A ratio from 4-wks of diabetes, and increased deceleration time, isovolumic relaxation time and A wave amplitude from 8-wks of diabetes. Cardiac hypertrophy (cardiomyocyte size) was evident from 8-wks, however gene expression of the hypertrophic marker  $\beta$ -myosin heavy chain and systemic inflammation (plasma TNF $\alpha$ ) were increased earlier (from 2-wks of diabetes). Cardiac fibrosis (% collagen deposition, CTGF gene expression) and DNA fragmentation were increased from 4-wks of diabetes. Markers of the HBP machinery (gene and protein levels) were increased at 16-wks of diabetes.

**Discussion:** This is the first study to investigate the progression of markers contributing to development of diabetic cardiomyopathy. Hyperglycaemia and systemic complications precede cardiac remodelling and dysfunction.

**136 Systemic and cardiac-selective targeting of histone deacetylase 4 (HDAC4) to limit diabetic cardiomyopathy**

Andrew M. Willis<sup>1,2</sup>, Mitchel Tate<sup>1</sup>, Miles J. De Blasio<sup>1</sup>, Darnel Prakoso<sup>1</sup>, Minh Deo<sup>1</sup>, Helen Kiriazis<sup>1</sup>, Xiao-Jun Du<sup>1</sup>, Paul Gregorevic<sup>1</sup>, Hong-Wei Qian<sup>1</sup>, Marianne Tare<sup>3</sup>, Rebecca H. Ritchie<sup>1,3</sup>, Baker Heart and Diabetes Institute<sup>1</sup>, Melbourne, VIC, <sup>2</sup>Dept. of Physiology and Dept. of Medicine<sup>3</sup>, Monash University, Clayton, VIC

**Introduction:** Diabetic cardiomyopathy is characterised by left ventricular (LV) diastolic dysfunction and structural changes, including cardiomyocyte hypertrophy and interstitial fibrosis. Epigenetic modifications, such as histone deacetylation, have been implicated in the molecular pathways that drive structural changes in this setting. HDAC4 is associated with the pathological cardiac remodelling similar to that observed in diabetic cardiomyopathy.

**Aims:** To determine whether inhibiting HDAC4, via a cardiac-selective approach using adeno-associated virus (AAV), or globally (by tasquinimod), ameliorates diabetic cardiomyopathy in a murine model of type-1 diabetes (T1D).

**Methods:** T1D was induced in 6 week old male FVB/N mice with streptozotocin (5 days, 55mg/kg/d or vehicle, i.p.). Echocardiography was performed at 6 (baseline), 14 (pre-treatment), and 22 (endpoint) weeks of age in anaesthetised mice (ketamine/xylazine/atropine, 60/6/0.6 mg/kg). The first approach utilised cardiac-selective rAAV6-dnHDAC4 (2x10<sup>11</sup> genomes or null vector). The second approach utilised tasquinimod (10mg/kg/d or vehicle administered via daily i.p.). Both approaches commenced after 8 weeks of diabetes with a follow-up period of 8 weeks.

**Results:** Blood glucose and HbA1c levels were increased with diabetes (P<0.0001). Diabetes reduced heart mass, however rAAV6-dnHDAC4 significantly increased LV mass compared to untreated diabetes (P<0.05). Diabetes-induced prolongation of isovolumetric relaxation time and increased LV connective tissue growth factor (CTGF) gene expression; both were attenuated by rAAV6-dnHDAC4 (P=0.08 and P<0.05, respectively) in T1D mice. Treatment with rAAV6-dnHDAC4 also blunted the diabetes-induced expression of hypertrophic genes including B-type natriuretic peptide (BNP) and  $\beta$ -myosin heavy chain ( $\beta$ -MHC, both P<0.05). Treatment with tasquinimod ameliorated diabetes-induced LV diastolic dysfunction with improved E/A and e'/a' in comparison to untreated diabetes (both P<0.01) and a reduction in deceleration time (P<0.01). Diabetes increased LV BNP gene expression (P<0.05) and superoxide levels (P<0.001) both of which were reduced by treatment with tasquinimod (both P<0.05).

**Conclusions:** Inhibition of HDAC4 attenuates characteristics of diabetic cardiomyopathy including cardiomyocyte hypertrophy, fibrosis, superoxide generation and LV diastolic dysfunction, in a model of T1D.

**137 Developing a new unit in a new curriculum**

Betty Exintaris, Drug Discovery Biology, Monash Institute of Pharmaceutical Sciences, Melbourne, VIC, Australia

**Introduction:** As of 2017, the Faculty of Pharmacy and Pharmaceutical Sciences at Monash University introduced a new Bachelor of Pharmacy (Honours)/Master of Pharmacy degree. The new degree seeks to equip graduates with the necessary skills and knowledge to lead practice in the ever-changing world of healthcare and medicine.

**Aims:** To develop a new, foundational, double credit point unit (How the Body Works).

**Methods:** The way in which the unit was to be delivered differed significantly from previous iterations of the unit. Firstly, the unit was a double credit point unit. Secondly the unit was delivered using a very structured approach: the 'DEAR' model. Briefly, on a weekly basis, for every 4 hours of pre-learning **D**iscovery (the information was presented in Moodle books, including revision questions), there were 4 hours of integrated lectures (students **E**xplored the discovery material using questions / scenarios posed by staff) and 4 hours of workshops (where students **A**ppplied the information from discovery and the integrated lectures. Finally students were asked to continuously **R**eflect on their learning. An important aspect of the new unit was the focus on skill development. In How the Body works we focussed on communication and teamwork.

**Results:** As a team, we developed and delivered a dynamic unit incorporating the new teaching approach. Staff reported that students were better communicators and team players by the end of the unit. Exam and unit results were noticeably higher (~20%) than the previous year.

Given the new teaching approach, it could be anticipated that students would initially struggle with the concept of having to be prepared before class so that the integrated lectures and workshops were meaningful. This was also true of students who had transferred from the old course or another course and were therefore used to the 'old' style of teaching. It was not surprising that the overall unit evaluation result was lower than other years (~3.5/5 vs ~4.5/5). Students provided meaningful feedback by identifying areas which could be improved.

**Discussion:** Utilising a different teaching approach, we developed a new unit as part of the new Pharmacy curriculum which focuses on skill development. Qualitative data suggests that the students were noticeably better communicators and team players by the end of the unit. Exam results also demonstrated that the students performed comparably better than last year. Feedback obtained from staff and students will be used to further develop the unit.

**138 What are the predictors of persistent prescription opioid analgesic use for non-cancer pain in Australia?**

Samanta Lalic<sup>1, 2</sup>, Natasa Gisev<sup>3</sup>, J Simon Bell<sup>1</sup>, Maarit J Korhonen<sup>1</sup>, Jenni Iilomäki<sup>1</sup>. Centre for Medicine Use and Safety, Monash University<sup>1</sup>, VIC, Australia; Pharmacy Department, Austin Health<sup>2</sup>, VIC, Australia; National Drug and Alcohol Research Centre, UNSW Australia<sup>3</sup>, NSW, Australia

**Introduction.** Long-term opioid analgesic use for chronic non-cancer pain is associated with uncertain clinical benefits but clear harms.

**Aims.** To identify patterns of opioid analgesic use and determined predictors of persistent opioid use among people without cancer.

**Methods.** A population-based cohort study of Australians initiating prescription opioids from July 2013 to December 2015 was conducted using data from a random 10% sample of people who accessed medicines through Australia's Pharmaceutical Benefits Scheme. A 12-month look-back period was used to define opioid initiation, exclude people with cancer, and determine comorbidities. Persistent use over 12-months since initiation was identified through group-based trajectory modelling. Odds ratios (OR) and 95% confidence intervals (CIs) for predictors of opioid persistence were estimated using logistic regression.

**Results.** The cohort consisted of 126,903 people who had opioids dispensed in  $\geq 2$  months during the 12-month follow up. A total of 11,323 (8.9%) persistent opioid users were identified. Predictors of persistence included initiation with transdermal opioids (OR 3.2, 95% CI 3.0-3.4), or with oral morphine equivalents (OME)  $\geq 750$  mg (OR 2.8, 95% CI 2.6-3.1), having depression (OR 1.3, 95% CI 1.3-1.4), or psychotic illness (OR 1.9, 95% CI 1.7-2.0). Previous dispensing of paracetamol (OR 1.7, 95% CI 1.6-1.8), pregabalin (OR 1.6, 95% CI 1.5-1.8) and benzodiazepines (OR 1.3, 95% CI 1.2-1.4) predicted persistence. Compared to people aged 18-44 years, those  $\geq 75$  years were 2.4 (95% CI 2.2-2.6) times more likely to be persistent users.

**Discussion.** Mental health comorbidities, older age, initiation with transdermal opioids and higher OMEs strongly predicted persistent opioid use among people without cancer. This information may help prescribers target monitoring and early intervention efforts in order to prevent opioid-related harms.

**139 Development of comorbidities in men with prostate cancer treated with androgen deprivation therapy: An Australian population-based cohort study**

Huah Shin Ng<sup>1</sup>, Bogda Koczwara<sup>2</sup>, David Roder<sup>3</sup> & Agnes Vitry<sup>1</sup>, <sup>1</sup>School of Pharmacy and Medical Sciences, University of South Australia, Adelaide, SA, Australia, <sup>2</sup>Flinders Centre for Innovation in Cancer, Flinders University, Adelaide, SA, Australia, <sup>3</sup>Cancer Epidemiology and Population Health, Centre of Population Health Research, School of Health Sciences, University of South Australia<sup>3</sup>, Adelaide, SA, Australia

**Introduction:** Many studies examined the prevalence of comorbidities at the time of cancer diagnosis but there is little information on the pattern of comorbidities following cancer diagnosis.

**Aims:** This study aims to assess the development of comorbidities among Australian men with prostate cancer treated with androgen deprivation therapy.

**Methods:** Pharmaceutical Benefits Scheme 10% data between January 2003 and December 2014 was utilised for this retrospective cohort study. Men who had received their first androgen deprivation therapy between years 2004 and 2010 were selected as the prostate cancer cohort. Dispensing claims data were used to identify comorbidities and classified with the Rx-Risk-V model. Comparisons were made between the prostate cancer cohort and specific control groups (age- and sex-matched at 1:10 ratio without any dispensing of anti-neoplastic agents during the study period and without the individual comorbidity of interest evaluated at baseline) for the development of nine individual comorbidities over time using Cox regression models.

**Results:** The prostate cancer cohort had a significant higher risk of developing cardiovascular conditions (Hazard Ratio 1.37, 95% CI 1.26-1.48), depression (1.86, 1.73-2.01), diabetes (1.30, 1.15-1.47), gastric acid disorders (1.48, 1.39-1.57), hyperlipidaemia (1.18, 1.09-1.29), osteoporosis (1.65, 1.48-1.85) and pain/pain-inflammation (1.47, 1.39-1.55) compared to non-cancer control groups. The Hazard Ratios for cardiovascular conditions and depression were highest in the first year and declined over time. There were no significant differences between the two groups for reactive airway diseases and dementia.

**Discussion:** Men with prostate cancer treated with androgen deprivation therapy had a higher incidence of developing new comorbidities than men without cancer. Our results support the need for developing coordinated models to effectively address multiple chronic diseases experienced by prostate cancer survivors.

**140 Antithrombotic prescribing for patients with a history of atrial fibrillation: An analysis using MedicineInsight data**Daniel Taylor<sup>1</sup>, Ludmila Ovchinnikova<sup>1</sup>, NPS MedicineWise<sup>1</sup>, Sydney, NSW, Australia

**Introduction:** Patients who receive an anticoagulant therapy for atrial fibrillation (AF) have typically been treated with warfarin. This has recently changed in Australia with the listing of three novel oral anticoagulants (NOACs) on the Pharmaceutical Benefits Scheme (PBS).

**Aims:** The aim of this study was to examine historical trends in antithrombotic prescribing and to examine the impact that the PBS-listing of NOACs has had on warfarin prescribing for patients with AF. The study also examines whether general practitioners (GPs) who participated in an academic detailing and discussion programme about anticoagulant use had different patterns of warfarin and NOAC prescribing behaviour following the PBS-listing.

**Methods:** Clinical data from MedicineInsight – a national database of longitudinal patient-level clinical information from general practices – was used to construct a monthly time series of the number of prescriptions and the number of AF patients prescribed each antithrombotic drug between 2000 and 2017. Autoregressive-moving-average models were used to estimate the trends and trend-changes that underlay each time series.

**Results:** In the AF-patient population, the total number of warfarin scripts and the total number of patients prescribed warfarin declined sharply following the PBS-listing of NOACs. Since the listing, the fraction of patients prescribed warfarin as part of an anticoagulant therapy declined from 72% to 36% and the fraction of patients prescribed a NOAC rose from 2% to 56%. General practitioners who participated in an academic detailing program prescribed warfarin and NOACs at a rate similar to those who did not, but they switched a larger fraction of patients onto NOACs in the first three months of the PBS-listing.

**Discussion:** The results of this study show that MedicineInsight data is a useful tool for evaluating the impact of drug policy changes and academic interventions on drug utilisation.

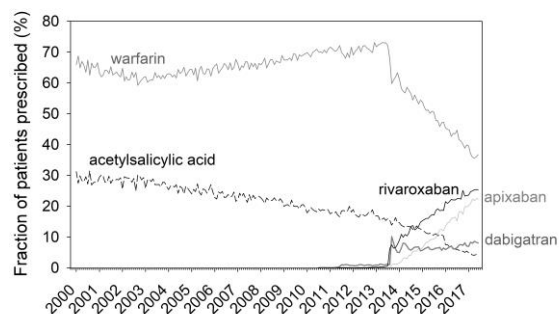
**141 Questions from Australian public and health professionals on medication use in breastfeeding: Comparative call analysis of two national medicines call centres**Treasure M McGuire<sup>1,2</sup>, Amelia Stephens<sup>3</sup>, Wendy Brodribb<sup>3</sup>, Laura Deckx<sup>3</sup>, <sup>1</sup>Mater Pharmacy, Mater Health<sup>1</sup>, Brisbane, QLD, Australia, <sup>2</sup>School of Pharmacy, UQ, Brisbane, QLD, Australia, <sup>3</sup>Discipline of General Practice, School of Medicine, UQ, Brisbane, QLD, Australia

**Introduction:** There is considerable uncertainty regarding medication use in breastfeeding. Resources provide differing data, making evidence-based information difficult for primary carers to deliver and consumers to access.

**Aims:** This study aimed to compare lactation-related questions from consumers and health professionals, to target education for safer medication use.

**Methods:** We conducted a retrospective, mixed method study of lactation-related calls extracted from two Australian medicines call centre databases National Prescribing Service (NPS) Medicines Line (ML) for the general public (2002-30 June 2010) and Therapeutic Advice and Information Service for health professionals (2000-30 June 2010). Top ranked medicines and classes of interest were identified and classified by their Anatomical Therapeutic Chemical Classification. Call narratives were explored to compare key themes.

**Results:** ML and TAIS received 5,662 and 2,219 lactation calls, respectively. Women, calling for themselves or family constituted 95% of consumer calls; while health professionals were mainly general practitioners (46%), community pharmacists (35%) and nurses (12%). Top ranked class of interest was nervous system for both consumers (21.8%) and health professionals (27%); however second ranked was respiratory system (17.2%) for consumers versus systemic anti-infectives (20%) for professionals. The most common classes of concern to women were medicines mainly accessible over-the-counter, with the top ranked individual medicines paracetamol (6.9%), ibuprofen (4.8%) and codeine (4.2%). In contrast, professional questions focused on prescription medicines such as antidepressants (16.9%), with queries on sertraline (3.7%), levonorgestrel (2.7%) and domperidone (2.4%) of most common. Themes of queries were, however, similar for both cohorts, focusing mainly around medication safety, risk minimisation and milk supply.

**Discussion:** Compelling and common themes drive medicines help-seeking in breastfeeding, with a general over-estimation of risk. Understanding where consumers' and health professionals' concerns differ is key to developing targeted resources; so primary carers can address mothers' concerns and information gaps.

### 142 Prevalence of potentially inappropriate medication use in older inpatients with and without cognitive impairment: a systematic review

Mitchell R Redston<sup>1</sup>, Sarah N Hilmer<sup>2,3</sup>, Andrew J McLachlan<sup>1,4</sup>, Alexander J Clough<sup>1</sup>, Danijela Gnjidic<sup>1,5</sup>. Faculty of Pharmacy<sup>1</sup>, University of Sydney, Sydney, NSW, Australia; Sydney Medical School<sup>2</sup>, University of Sydney, Sydney, NSW, Australia; Departments of Aged Care and Clinical Pharmacology, Kolling Institute of Medical Research, Royal North Shore Hospital<sup>3</sup>, Sydney, NSW, Australia; Centre for Education and Research on Ageing, Concord Repatriation General Hospital<sup>4</sup>, Sydney, NSW, Australia; Charles Perkins Centre<sup>5</sup>, University of Sydney, Sydney, NSW, Australia

**Introduction.** Older people with cognitive impairment are high users of acute care services in Australia and internationally. Potentially inappropriate medication (PIM) use may be associated with adverse outcomes, including hospital re-admission, functional disability and mortality.

**Aims.** This systematic review aims to quantify and compare the prevalence of PIMs in older inpatients with and without cognitive impairment.

**Methods.** A systematic search for observational studies was performed in Embase, Medline/PubMed, PsycINFO, International Pharmaceutical Abstracts, Scopus and Informat. Articles published in English during the period January 2007–June 2017 that reported the prevalence of PIMs in hospital inpatients  $\geq 65$  years were included. PIMs were defined as exposure to polypharmacy (multiple medication use) or using implicit or explicit tools, such as the Beers criteria and *Screening Tool of Older Person's Prescriptions* (STOPP). Two reviewers independently assessed the articles for eligibility and extracted the data.

**Results.** 47 articles were included. The prevalence of PIMs defined by polypharmacy exposure (n=15) ranged from 53.2% to 89.8% when cognitive impairment was reported, and 24.0% to 97.1% when unreported. In studies employing explicit and implicit tools (n=35), the prevalence of PIMs in where cognitive impairment was reported ranged from 20.6% to 80.5% using the Beers criteria, and 39.3% to 88.5% using STOPP. When cognitive status was unreported, the prevalence of PIMs ranged from 7.0% to 79.2% using the Beers criteria, and 20.0% to 63.4% using STOPP.

**Discussion.** Current published evidence suggests a substantial variation in the prevalence of PIMs in older inpatients with and without cognitive impairment. Future studies should investigate the impact of PIM use on patient-centred outcomes to inform enhanced acute care services and pharmacist interventions to reduce inappropriate prescribing.

### 143 Health professionals' and researchers' opinions on conducting clinical deprescribing trials

Alexander J Clough<sup>1,2</sup>, Sarah N Hilmer<sup>2</sup>, Lisa Kouladjian-O'Donnell<sup>2</sup>, Sharon L Naismith<sup>3</sup>, Danijela Gnjidic<sup>1,2,3</sup>, <sup>1</sup>Fac of Pharmacy, Univ of Sydney, Camperdown, NSW, Australia, <sup>2</sup>Kolling Inst, Royal North Shore Hospital and Univ of Sydney, St Leonards, NSW, Australia, <sup>3</sup>Brain & Mind Research Inst, Univ of Sydney, Camperdown, NSW, Australia

**Introduction:** Clinical deprescribing trials can be conducted to produce favourable health outcomes in people taking potentially harmful medications. At present, there are no guidelines on conducting deprescribing studies.

**Aims:** To determine the perspectives, attitudes, interests, barriers, and enablers in relation to conducting clinical deprescribing trials among health professionals and researchers.

**Methods:** An anonymous survey was developed, reviewed and piloted by all investigators for content validity. Experts were contacted to inform the questionnaire content, which explored the purposes, enablers, and barriers of conducting deprescribing trials. The survey was distributed to members of national and international: deprescribing, pharmacological, and pharmacy organisations; and to researchers published in deprescribing.

**Results:** The survey was completed by 96 participants from June–August 2017. Participants indicated the main rationale for conducting deprescribing trials is to assess the efficacy of interventions to optimise clinical centred outcomes (79.2%). Common barriers to conducting deprescribing trials were forming relationships and maintaining communication with other health professionals involved in the deprescribing process. This barrier commonly affected the: effective completion of trials (32.0%); recruitment of potential patients (31.0%); and overall conduction of trials (17.1%). The most common reported enabler was the belief of health professionals treating trial patients that deprescribing was beneficial (24.4%). Classical randomised controlled trials were considered the most appropriate method for conducting deprescribing trials (93.2%) vs. crossover trials (45.2%). 60.0% of participants indicated a legal, regulatory, and good practice framework required developing, but only 38.9% stated that the CONSORT list needed to be updated to encompass deprescribing trials.

**Discussion:** Preliminary findings indicate recognition of the need for high quality randomised controlled deprescribing trials and the importance of engagement of treating clinicians in trials of these complex multidisciplinary interventions. Furthermore, the findings of this survey could inform a future clinical deprescribing trial framework, which participants indicated was required.

#### 144 Population pharmacokinetics of carboplatin, etoposide and melphalan (CEM) in children with high-risk neuroblastoma

Janna K Duong<sup>1</sup>, Gareth J Veal<sup>2</sup>, Christa E Nath<sup>1,3</sup>, Peter J Shaw<sup>3,4</sup>, Julie Errington<sup>2</sup>, Alan V Boddy<sup>2</sup>, <sup>1</sup>Faculty of Pharmacy, The University of Sydney, Sydney, NSW, Australia, <sup>2</sup>Northern Institute for Cancer Research, Newcastle University, Newcastle upon Tyne, United Kingdom, <sup>3</sup>The Children's Hospital at Westmead, Westmead, Australia, <sup>4</sup>Discipline of Child and Adolescent health, Faculty of Medicine, The University of Sydney, Sydney, NSW, Australia

**Introduction:** Carboplatin, etoposide and melphalan (CEM) are cleared by the kidneys and renal function is expected to influence the pharmacokinetics of CEM. In children, however, estimating the renal function (glomerular filtration rate, GFR) may be problematic.

**Aims:** The aims of this study were to investigate factors that influence the pharmacokinetics of component CEM drugs in children and to determine whether pre-defined exposures for carboplatin were achieved using current dosing regimens.

**Methods:** Data were obtained from the European SIOP Neuroblastoma study (SIOPEN). The data were used to build a population pharmacokinetic model for CEM component drugs. Various covariates (weight, age, sex, BSA, BMI, GFR and study site) were investigated. The final model was used to simulate whether target carboplatin exposures (16.4 mg/mL·min) were achieved using the paediatric Newell formula, Calvert formula or weight-based dosing.

**Results:** A total of 51 patients with 1031 observations were used to build a population model. The median age of the patients was 3.5 years (1.7 – 8.3 years, range) and median GFR was 38 mL/min (23 – 75 mL/min). A two-compartment model provided the best fit for each of the three drugs. An allometric weight model was used for all pharmacokinetic parameters. None of the other covariates, including GFR, were significant after accounting for weight. For carboplatin, the Newell formula was successful in achieving the target area under the curve (AUC) for children with GFR of 30 mL/min (43%), 30 – 60 mL/min (43%) and >60 mL/min (32%), but a weight-based dose of 50 mg/kg was found to target the AUC more consistently than the Newell formula across a range of GFR values (46%, 45% and 47% respectively). Use of the Calvert formula would result in significant overdosing.

**Discussion:** Weight-based dosing is an adequate alternative to dosing carboplatin to achieve target AUC.

#### 145 The novel fatty acid epoxide analogue CTU targets the mitochondrion and depletes cardiolipin to promote killing of MDA-MB-231 breast cancer cells

Hassan Choucair<sup>1</sup>, Bala Umashankar<sup>1</sup>, Kirsi Bourget<sup>1</sup>, Yongjuan Chen<sup>1</sup>, Tristan Rawling<sup>2</sup>, Michael Murray<sup>1</sup>, <sup>1</sup>Discipline of Pharmacology, University of Sydney, Sydney, NSW, Australia, <sup>2</sup>School of Mathematical and Physical Sciences, University of Technology Sydney, Sydney, NSW, Australia

**Introduction:** The atypical phospholipid cardiolipin plays an important regulatory role in apoptosis by modulating the release of cytochrome c from the mitochondrial membrane. We have prepared a metabolically stable fatty acid epoxide bioisostere (termed CTU) that targets the mitochondrion and activates endoplasmic reticulum stress in MDA-MB-231 breast cancer cells leading to decreased cell viability (Choucair et al, ASCEPT 2016).

**Aims:** This study was undertaken to evaluate the role of the mitochondrion in CTU-mediated cancer cell killing.

**Methods:** In MDA-MB-231 cells, cardiolipin/phosphatidylglycerol was estimated using a commercial kit. Cell viability was assessed by ATP formation, measurement of caspase-3/7 activity and annexin V/7AAD staining. Gene profiling was undertaken by real-time RT-PCR, and altered protein expression was assessed by Western immunoblotting.

**Results:** Addition of CTU to MDA-MB-231 cells significantly decreased the cellular content of cardiolipin and its precursor phosphatidylglycerol at 24 h. Mitochondrial cytochrome c release was increased in cells treated with CTU at 24 h but not at 6 h. However, the expression of pro-apoptotic mitochondrial membrane permeabilizing proteins of the Bcl-2 family, Bax and Bak, was decreased at 6 and 24 h. Neither the Ca<sup>2+</sup> chelator BAPTA-AM nor the mitochondrial permeability transition pore inhibitor cyclosporin A altered the CTU-mediated decrease in ATP formation. Co-supplementation with the monounsaturated fatty acid oleic acid, which is essential for cardiolipin maintenance, prevented the CTU-mediated depletion of cardiolipin/phosphatidylglycerol, upregulation of endoplasmic reticulum stress genes, mitochondrial cytochrome c release, caspase-3/7 activation and annexin V/7AAD staining.

**Discussion:** The novel fatty acid bioisostere CTU has emerged as the first in a new class of agents with activity against cancer cells produced by targeting of the tumor cell mitochondrion and cardiolipin depletion. CTU-mediated apoptosis in MDA-MB-231 cells is independent of Bax and Bak and the mitochondrial permeability transition pore.

Choucair H et al (2016) ASCEPT 2016.

**146 The potential of MK2 inhibitors in glioblastoma therapy**

Lenka Munoz<sup>1</sup>, <sup>1</sup>School of Medical Sciences, Faculty of Medicine, The University of Sydney, Sydney, NSW, Australia

**Introduction:** MAPK-activated protein kinase 2 (MK2) is a checkpoint kinase regulating DNA damage response (DDR), a mechanism that is crucial for survival of cancer cells. Defects in the DNA damage response can be exploited therapeutically and kinases of the DDR machinery, including MK2, have been identified as promising avenues for targeted cancer therapeutics.

**Aims:** We aimed to determine whether MK2 inhibition attenuates glioblastoma cell survival.

**Methods:** Orthogonal MK2 inhibitors and genetic knock-down, including CRISPR deletion of MK2, were tested in an array of functional and mechanistic studies employing established and patient-derived glioblastoma stem cell lines.

**Results:** We determined that MK2 inhibition improves efficacy of chemotherapy in glioblastoma-relevant models through a novel mechanism targeting the p53 tumour suppressor protein. Intriguingly, we also discovered an unexpected non-kinase target for an allosteric MK2 inhibitor CMPD1. The intellectual property of CMPD1 has been licensed to an industry partner and preclinical development of CMPD1 for the treatment of glioblastoma is currently ongoing within our academia-industry collaboration.

**Discussion:** I will present published and novel data revealing MK2 signalling axis in glioblastoma cells, as well as the latest data on the preclinical development of CMPD1. I will discuss how in-depth pharmacological understanding of a molecular target is necessary in the early stages of the drug discovery and how mechanism of action can determine later success or failure of the emerging drug candidates.

Gurgis F et al (2015) Cell Death Discov 1: 15028

Phoa A et al (2016) Biochem Pharmacol 98:587-601

Munoz L (2017) Nature Rev Drug Discov 16:424 - 440

**147 Induction of apoptosis in triple negative breast cancer cells by selenium derivatives**

Jackmil P Jogy, Gregory I Giles, Department of Pharmacology and Toxicology, University of Otago, Dunedin, Otago, New Zealand

**Introduction:** Triple negative breast cancer (TNBC) is the most common cancer among New Zealand women and is highly difficult to treat, with approximately a 30 % mortality rate. Previous studies have indicated that organoselenium compounds exhibit cytotoxicity against some cancer cell lines, raising the possibility that selenium based drugs could be effective as therapeutics for breast cancer.

**Aims:** To investigate the effect of the organoselenium agents diphenyl selenide (DPS) and diphenyl diselenide (DPDS) on cell growth in the TNBC cell lines: MDA-MB-231, MDA-MB-468 and HS-578T; and as a comparison MCF-7 oestrogen positive (ER+) cells, and SKBR3 human epidermal growth factor receptor 2 positive (HER2+) cells.

**Methods:** Cell viability was assessed using MTT assay and validated by double labelling with the fluorescent probes Hoechst 33342 and propidium iodide. Morphological changes were observed using phase contrast microscopy. Expression of p53 and caspase-3 was assessed using western blotting and an Ac-DEVD-AMC fluorogenic substrate assay was used to measure caspase-3 activity. Apoptotic cells were detected using a YO PRO-1 assay.

**Results:** DPS showed no anti-cancer effect against any breast cancer cells; however, DPDS showed potent cytotoxicity with IC<sub>50</sub>s in the range 7-18 µM against towards TNBC cells, and 27 µM against MCF-7s. Interestingly DPDS did not display cytotoxicity towards SKBR3, suggesting selective action towards TNBC cells. Molecular analysis indicated that DPDS induced cell death via apoptosis in TNBC cells correlating with increase in p53 and caspase-3 activation.

**Discussion:** Generally DPDS is cytotoxic against cell lines at concentrations greater than 30 µM. The present data indicate that DPDS displays considerably higher cytotoxicity towards TNBC compared to other cancer cell lines, suggesting that DPDS could find therapeutic applications as a treatment for TNBC.

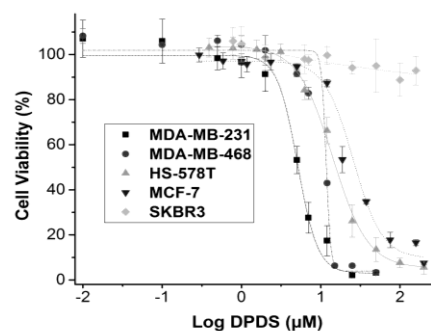

**148 The effect of curcumin on in vitro metabolism and predicted in vivo exposure of imatinib**

Jeffrey Adiwidjaja<sup>1</sup>, Alan V Boddy<sup>1</sup> & Andrew J McLachlan<sup>1,2</sup>, <sup>1</sup>Fac of Pharmacy, Univ of Sydney, Sydney, NSW, Australia, <sup>2</sup>Centre for Education and Research on Ageing, Concord Repatriation General Hosp, Sydney, NSW, Australia

**Introduction:** Imatinib is the first-line agent for the treatment of chronic myeloid leukaemia (CML) and is a substrate for CYP3A4 (Hochhaus et al, 2017). Curcumin has been investigated for anti-cancer activities, including for CML, and is a relatively potent CYP3A4 inhibitor (Adiwidjaja et al, 2017).

**Aims:** The aim of this study is to investigate the metabolism-based interaction between curcumin and imatinib.

**Methods:** Imatinib metabolism was investigated in pooled human liver microsomes (HLM) and recombinant CYP3A4 enzymes in the presence and absence of curcumin using LC-MS/MS assay for N-desmethyl metabolite. Azamulin, a specific CYP3A4 mechanism-based inhibitor, was used to study the effect of curcumin on imatinib N-demethylation by other (non-CYP3A4) pathways.

**Results:** A simple Michaelis-Menten model best fitted to N-desmethyl imatinib formation kinetic in HLM ( $K_m = 6.16 \pm 0.63 \mu\text{M}$ ;  $V_{max} = 94.27 \pm 3.83 \text{ pmol.mg protein}^{-1}.\text{min}^{-1}$ ). Curcumin inhibited CYP3A4 and non-CYP3A4-mediated imatinib N-demethylation competitively (Figure 1) and noncompetitively with a  $K_i$  of  $0.73 \pm 0.12$  and  $1.88 \pm 0.19 \mu\text{M}$  respectively. Using a static drug interaction model, a single 160 mg- and multiple (320 mg every 12 h)-oral dose of curcumin were predicted to increase imatinib exposure ( $AUC_{0-\infty}$ ) by 16 and 21%, respectively.

**Discussion:** Based on the  $K_i$  value, the formation of N-desmethyl imatinib mediated by CYP3A4 was more susceptible to inhibition by curcumin than that through non-CYP3A4 (most likely by CYP2C8) pathway. Curcumin at a clinically-relevant concentration was predicted to increase imatinib systemic concentrations by up to 21%. This moderate interaction is worthy of further study in the clinic.

Adiwidjaja J et al (2017) Expert Opin Drug Metab Toxicol 13(9):953-72

Hochhaus A et al (2017) N Engl J Med 376(10):917-27

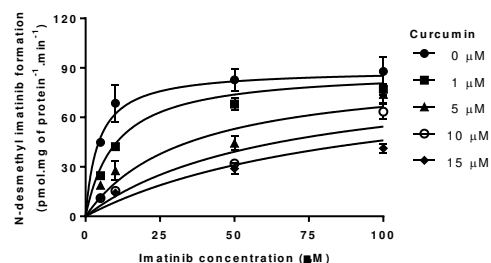

Figure 1

**149 Triterpenoid micellar nanoparticles for the treatment of glioblastoma: Potential inhibition of the PI3K/Akt signalling**

Rebecca H Roubin, Yat Sum William Wah, Peter Pirotta, Ramin Rohanzadeh, Jane R Hanrahan, Faculty of Pharmacy, The University of Sydney, Sydney, NSW

**Introduction:** Glioblastoma is the most aggressive type of malignant brain tumour and is associated with a high mortality rate. Current standard therapy for glioblastoma is inadequate due to tumour resistance and recurrence. Recent efforts in producing targeted therapies for glioblastoma have also faced challenges due to the blood brain barrier and the tumour heterogeneity of glioblastomas. As a result, there is a need for novel treatment strategies. Triterpenoid derivatives are well known to possess a wide range of anti-cancer effects. With its multifaceted action, selective toxicity, chemosensitising effect and ability to penetrate the blood brain barrier, triterpenoids are believed to have a potential role in the treatment of glioblastoma. However, the limited aqueous solubility and non-specific bio-distribution of triterpenoid derivatives have been obstacles to its clinical application. An effective method for delivering triterpenoid derivatives has yet to be developed that would further elucidate the precise mechanism of triterpenoid derivatives in treating glioblastoma.

**Aims:** To develop triterpenoid derivative micellar nanoparticles that would further elucidate the precise mechanism of triterpenoid derivatives in treating glioblastoma.

**Methods:** Triterpenoid derivatives were synthesised into nanoparticles using micelles. The particle size, encapsulation efficiency, in vitro release, stability, cytotoxicity, and cellular uptake of these triterpenoid nanoparticles were characterised in human glioblastoma (U87MG) cells.

**Results:** Micellar nanoparticles significantly improve triterpenoid derivatives solubility, stability, and bioavailability in vitro ( $n = 3$ ,  $P < 0.05$ ). Micellar nanoparticles significantly improve the anti-glioblastoma dose dependent inhibition of the triterpenoids compared to the standard chemotherapeutic agent, temozolomide ( $n = 3$ ,  $P < 0.05$ ).

**Discussion:** We hypothesise that triterpenoid derivatives may be inhibiting the PI3K/Akt signalling pathway, which plays a major role in mediating the responses of glioblastoma cells to triterpenoid derivatives, and the potential use of triterpenoid derivatives in treating glioblastoma.

### 150 Predictors of adverse drug reaction-related hospitalisation in Southwest Ethiopia: A prospective cross-sectional study

Mulugeta Tarekegn Angamo<sup>1</sup>, Leanne Chalmers<sup>1</sup>, Colin Michael Curtain<sup>1</sup>, Daniel Yilma<sup>2</sup>, Luke Bereznicki<sup>1</sup>, School of Medicine, University of Tasmania<sup>1</sup>, Hobart, Tasmania; Faculty of Medical Sciences, Jimma University<sup>2</sup>, Jimma, Ethiopia.

**Introduction:** Adverse drug reactions (ADRs) are important causes of morbidity and mortality in the healthcare system; however, there are no studies reporting on the prevalence and risk factors associated with ADR-related hospitalisation in Ethiopia.

**Aim:** To identify predictors of ADR-related admission to the Jimma University Specialised Hospital, Southwest Ethiopia.

**Methods:** A prospective cross-sectional study was conducted from May 2015 to August 2016 among patients aged  $\geq 18$  years consecutively admitted to medical wards of Jimma University Specialised Hospital taking at least one medication prior to admission. ADR-related hospitalisations were determined through expert review of medical records, laboratory tests, patient interviews and physical observation. ADR causality was assessed by the Naranjo algorithm followed by consensus review with senior internist. ADR preventability was assessed using the Schumock and Thornton criteria. Only definite and probable ADRs that provoked hospitalisation were considered.

**Results:** Of 1,001 patients, 103 (10.3%) had ADR-related admissions. A total of 119 ADRs (1.2 ADRs per patient) were identified. Common ADRs responsible for hospitalisation were hepatotoxicity (35, 29.4%) and acute kidney injury (28, 23.5%). The drug classes most frequently implicated were antitubercular agents (43, 23.9%) followed by antivirals (21, 11.7%) and diuretics (21, 11.7%). Independent predictors of ADR-related hospitalisation were body mass index (BMI)  $< 18.5$  kg/m<sup>2</sup> (adjusted odd ratio [AOR]=1.69; 95%CI=1.10-2.62; P=0.047), pre-existing renal disease (AOR=2.84; 95%CI=1.38-5.85, P=0.004), pre-existing liver disease (AOR=2.61; 95%CI=1.38-4.96; P=0.003), number of comorbidities  $\geq 4$  (AOR=2.09; 95%CI=1.27-3.44; P=0.004), number of drugs  $\geq 6$  (AOR=2.02; 95%CI=1.26-3.25; P=0.004) and history of previous ADRs (AOR=24.27; 95%CI=11.29-52.17; P<0.001). Most ADRs (106, 89.1%) were preventable.

**Discussion:** Over half of the ADR-related admissions were due to hepatotoxicity and acute kidney injury. The majority of ADRs were preventable, highlighting the need for monitoring and review of patients with lower BMI, ADR history, renal and liver diseases, multiple comorbidities and medications. ADR predictors should be integrated into clinical pathways and pharmacovigilance systems.

### 151 Investigating the Impact of Universal Healthcare Coverage on the practice of Indonesian Community Pharmacy: A Qualitative Study

Andi Hermansyah<sup>1,2</sup>, Erica Sainsbury<sup>1</sup>, Ines Krass<sup>1</sup>, <sup>1</sup>Faculty of Pharmacy, The University of Sydney, Sydney, NSW, Australia, <sup>2</sup>Faculty of Pharmacy, Airlangga University, Surabaya, Indonesia

**Introduction:** The introduction of Universal Healthcare Coverage (JKN) to Indonesian health system in 2014 has changed the landscape of Community Pharmacy (CP) sector opening up opportunity for CPs to operate within the JKN scheme including receiving remuneration for supply of medicines. However, to date, there has been no research investigating the impact of such changes to the practice of pharmacy and pharmacists.

**Aims:** To explore key stakeholders' perception and experiences on the influence of JKN on CP practice.

**Methods:** In-depth, semi structured interviews were conducted to broad range of key stakeholders in CP and healthcare system from February to July 2016. The interviews were audio-recorded, transcribed verbatim and analysed for emerging themes. Ethics approval was obtained from the University of Sydney

**Results:** A total 29 key informants participated. Three levels of practice i.e micro (individual pharmacist), meso (organisational context of CP) and macro (external CP environment) were analysed interdependently. Stakeholders perceived that JKN has not improved scope of practice in CP which still predominantly focuses on dispensing. In addition, there has been little impact for pharmacists in terms of remuneration and role acknowledgement. Stakeholders also perceived no significant benefits for a CP joining JKN. However, they were aware that the limited opportunity under JKN was the result of a number of barriers including pharmacists' shortage, poor law enforcement and lack of pharmacists' clinical competence of which may not always relate to policy changes provided by JKN.

**Discussion:** While JKN has been designed to improve primary care system, it has not addressed key structural changes within CP sector. As a result, community pharmacy continues to be hampered by structural and fundamental issues even after the introduction of JKN.

MoH Indonesia (2004) National Social Security Law

Plummer V and Boyle M (2016) Financing Healthcare in Indonesia, *Asia Pac J of Health Man*, 11(2), pp.33-38

**152 Home Medicines Reviews – Exploring accredited pharmacists' work processes**

Marea Patounas<sup>1</sup>, Esther Lau<sup>1</sup>, Greg Kyle<sup>1</sup>, Debbie Rigby<sup>1</sup>, Lisa Nissen<sup>1</sup>, Vincent Chan<sup>2</sup>, <sup>1</sup>Faculty of Health, School of Clinical Sciences, QUT, Brisbane, QLD, Australia, <sup>2</sup>RMIT University<sup>2</sup>, Melbourne, VIC, Australia

**Introduction:** In healthcare, work processes shape patient, professional and organisational outcomes. Little is known about the specific tasks and activities that form the work processes of accredited pharmacists (APs) performing Home Medicines Reviews (HMRs) in Australia.

**Aims:** To explore APs' work processes and the time taken to conduct the three stages of HMR: pre-interview (preparation phase); home interview (with the patient); and post-interview (collation of findings and recommendations into a HMR Report for the patient's General Practitioner).

**Methods:** Focus groups and semi-structured interviews were conducted with Australian APs. Participants were recruited via professional pharmacy networks and organisations. The sessions were transcribed verbatim and thematically analysed using Leximancer and NVivo 11 software.

**Results:** There were 10 APs in the focus groups and 15 APs who participated in the semi-structured interviews. Participants for the two focus groups were from southeast Queensland, and interview participants ranged from urban, regional and far north Queensland, to northern regional and western regional New South Wales. The configural work system processes for each stage of HMR were categorised as: person, task, technology, organisation, and internal and external environment factors. The APs focussed on establishing rapport and trust with the patient as a top priority. The majority of APs spent an estimated 4 hours performing a HMR from beginning to end, with the majority of pre-interview, home interview and post-interview stages taking 30-60 minutes, 45-60 minutes and 1.5-2 hours respectively. Most HMR reports were 2-4 pages in length, although this varied depending on whether the AP worked from a home office or if they were a practice pharmacist (integrated into a clinic/practice setting).

**Discussion:** A detailed account of APs' HMR tasks and work processes may be of practical value to medical home decision makers, funding bodies, professional organisations, educators and health professionals involved in medication reviews. Further investigation of APs' work processes and the time taken to conduct HMRs is warranted.

**153 Adoption of the Ohio Emergency Department opioid prescribing guidelines**

Jonathan Penm<sup>1</sup>, Neil MacKinnon<sup>2</sup>, Jill Boone<sup>2</sup>, Erin Winstanley<sup>2</sup>, Michael Lyons<sup>3</sup>, Edmond Hooker<sup>3</sup>, Steve Carlton-Ford<sup>4</sup>, Rebecca Mashni<sup>2</sup>, Chloe Connelly<sup>2</sup>, Erica Tolle<sup>2</sup>, <sup>1</sup>Faculty of Pharmacy, University of Sydney, NSW, <sup>2</sup>College of Pharmacy, College of Medicine<sup>3</sup>, College of Arts and Sciences<sup>4</sup>, University of Cincinnati, OH, USA

**Introduction:** Ohio has the fifth highest rate of prescription opioid-related overdose deaths in the United States. The Ohio Department of Health has disseminated multiple guidelines, including the Emergency Department (ED) opioid prescribing guidelines, to aid address this issue.

**Aims:** To evaluate the adoption of the Ohio ED opioid prescribing guidelines, their perceived impact and factors affecting its adoption.

**Methods:** The study design was a cross-sectional survey of ED medical directors, or appropriate person identified by the hospital, perception of the impact of the Ohio ED Opioid Prescribing Guidelines on their departments practice. All hospitals with an ED in Ohio were contacted in 2016. Distribution followed Dillman's Tailored Design Method, augmented with telephone recruitment. Hospital chief executive officers were contacted when necessary to encourage ED participation. At the end of the survey, respondents were asked to participate in a semi-structured interview to assess barriers related to the implementation of the guidelines.

**Results:** A 92% response rate was obtained (150/163 EDs). In total, 112 (75%) of the respondents stated that their ED has an opioid prescribing policy, is adopting one, or is implementing prescribing guidelines without a specific policy. Of these 112 EDs, 81 (72%) based their policy on the Ohio ED Opioid Prescribing Guidelines. The majority of respondents strongly agreed/agreed that the prescribing guidelines have increased the use of the prescription drug monitoring program (86%) and have reduced opioid prescribing (71%). Main themes identified from 20 interviewees included the need for (1) increasing organizational responsibility, (2) assistance with prescription monitoring program utilization, (3) reducing the effect of patient satisfaction scores on opioid prescribing, and (4) increasing patient involvement.

**Discussion:** This study showed that the Ohio ED opioid prescribing guidelines have been widely disseminated and that the majority of EDs in Ohio are using them to develop local policies. The majority of respondents believed that opioid prescribing guidelines reduced opioid prescribing. However, prescribing practices still varied greatly between EDs.

**154 Pharmacy in the community: The potential of role extension**

Caroline Morris<sup>1</sup>, Janet McDonald<sup>2</sup>, Phoebe Dunn<sup>2</sup>, Ausaga Fa'asalele Tanuvasa<sup>2</sup>, Jane McCormack<sup>2</sup>, Kirsten Smiler<sup>2</sup>, Lynne Russell<sup>2</sup>, Jacqueline Cumming<sup>2</sup>, Department Primary Health Care and General Practice, University of Otago<sup>1</sup>, Wellington, NZ, Health Services Research Centre, Victoria University<sup>2</sup>, Wellington, NZ

**Introduction:** Community pharmacists (CPs) are a very accessible, highly trained and skilled workforce not currently being used to their full potential. They are well positioned to contribute to improvements in health outcomes and a reduction in health disparities by expanding their roles in both the individual patient care and population health arenas. In a similar way to other countries internationally, changes are occurring in pharmacy models of care, services and funding in New Zealand (NZ) to optimise the use of pharmacists' skills.

**Aims:** To understand current developments in community pharmacy services in NZ including the extent to which the expansion of roles is successfully occurring and what the enablers or barriers to this progress might be.

**Methods:** Thirty key informant, semi-structured, audio-recorded interviews conducted face-to-face or by telephone have been undertaken to date with a diverse range of stakeholders from the policy, pharmacy, consumer, general practice and nursing sectors (including Maori and Pacific views). Participants' views on current pharmacy services and policy were explored, as were their perceptions of what expanded pharmacy services might look like over the next three to five years. Interviews were transcribed verbatim, coded and analysed using a thematic approach.

**Results:** Data identified a range of factors with the potential to impact on current and future pharmacy roles. These were: national drivers for change, national and local policy development, CP workforce development, relationships with other health professional groups, impact of role change on service stakeholders including consumers, pharmacists and the wider health system. Other factors identified as influencing implementation and success included funding models, infrastructure within the pharmacy premises and national and local leadership.

**Discussion:** These key informant interviews form the first part of a larger study exploring how changes in community pharmacy services in NZ are expected to influence health and health service outcomes, identify the context in which success is occurring (or being hindered) and the mechanisms by which change is being achieved. The findings will be used to focus the second phase of the study, a national questionnaire e-survey of CPs.

**155 Just rubbish? Examining the concerns and attitudes of pharmacists to pharmaceuticals entering the environment**

Judith A. Singleton<sup>1,2</sup>, Esther T.L. Lau<sup>1,2</sup>, Lisa M. Nissen<sup>1,2</sup>, <sup>1</sup>School of Clinical Sciences, QUT, Brisbane, QLD, Australia, <sup>2</sup>Institute of Health and Biomedical Innovation, QUT, Brisbane, QLD, Australia

**Introduction:** Pharmaceuticals entering the environment have a cumulative negative effect on human health and wildlife (Daughton & Ruhoy, 2008).

**Aims:** To explore if an individual's level of environmental concern regarding the impact of pharmaceuticals entering the environment is a predictor of their environmental attitude.

**Methods:** A purposive sample of 41 pharmacists and 25 pharmacy technicians (n = 66) working in five hospitals in Brisbane, Australia, first completed the 15-item NEP scale questionnaire (to determine their environmental attitude) and then answered the question, 'How concerned are you personally about pharmaceuticals entering the environment?'

**Results:** A two-sample t-test was used to determine if there was a statistically significant association between participants' concern and environmental attitude. Equality of variances between the two groups 'Concerned' and 'Not Concerned' was checked using Levene's test, and equality was assumed to be the same (F = 0.181, p = 0.672). There was a statistically significant difference in mean NEP scores between concerned participants and participants who were not concerned (t<sub>62</sub> = 2.342, p = 0.022). The mean NEP score was 3.631 points lower for participants who did not express concern regarding the impact of pharmaceuticals on the environment.

**Discussion:** This study demonstrated that participants who reported being concerned about the impact of pharmaceuticals on the environment had a higher NEP score (a more pro-environmental attitude). Since environmental attitude influences pro-environmental behaviour, providing environmental knowledge to raise concern may indirectly influence pro-environmental behaviours in hospital pharmacy departments and warrants further investigation.

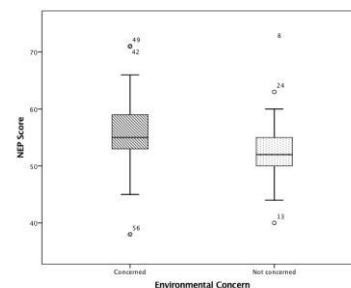

Daughton, C. G., & Ruhoy, I. S. (2008). The Afterlife of Drugs and the Role of PharmEcovigilance. *Drug Safety*, 31(12), 1069-1082. doi:10.2165/0002018-200831120-00004

**156 Adherence to lipid lowering medications for secondary prevention of stroke**

Judith A Coombes<sup>1,2</sup>, Debra Rowett<sup>1</sup>, Jennifer Whitty<sup>1</sup>, Darshan Shah<sup>2</sup>, William N Cottrell<sup>1</sup>, <sup>1</sup> School of Pharmacy, University of Queensland, Brisbane, QLD, Australia, <sup>2</sup>Medical Stroke Unit, Princess Alexandra Hospital, Brisbane, QLD, Australia

**Introduction:** To maximise risk reduction of recurrent stroke, good adherence to medications for secondary prevention is desired.

**Aims:** To compare patient self-report of adherence to lipid lowering medications with adherence calculated using Australian pharmaceutical benefits scheme (PBS) claims data.

**Methods:** Participants with a diagnosis of stroke or transient ischemic attack (TIA), and Mental Status Quotient (MSQ) of 10/10 who provided consent were recruited into the study. Participant self-report of adherence using the Medication Adherence Questionnaire (MAQ)(Morisky, et al. 1986) with a best possible score of 4/4, was obtained by telephone follow-up at least 3 months after discharge from hospital. Pharmaceutical claims data was used to obtain prescription refill dates and calculate the Proportion of Days covered by their medications (PDC)(Hedegaard, et al. 2014). Comparison of the results of these two adherence measures were analysed using Mann-Whitney U Test.

**Results:** We obtained both PBS and patients self-report adherence data for 43 of 60 recruited participants. At a mean of 120 days, 33/43(77%) participants self-reported good adherence (MAQ=4/4). In those participants with self-reported good adherence, the median PDC for 120 days was significantly higher ( $p=0.047$ ) at 96% (IQR 18%) compared 83% (IQR 18%) to those with adherence scores less than 4/4 on the MAQ.

**Discussion:** The analysis showed that there was a relationship between participant self-reported adherence and PBS medication refill data. The combination of both these results provides a clearer picture than each one taken in isolation.

**157 Cost-effectiveness of pharmacist management of hypertension**

Carlo A. Marra<sup>1</sup>, Karissa Johnston<sup>2</sup>, Valerie Santschi,<sup>3</sup> and Ross T. Tsuyuki<sup>4</sup>, <sup>1</sup>School of Pharmacy, University of Otago, Dunedin, NZ, <sup>2</sup>Broadstreet Health Outcomes, Vancouver, BC, Canada, <sup>3</sup>La Source School of Nursing Sciences, University of Applied Sciences Western Switzerland, Lausanne, Switzerland, <sup>4</sup>University of Alberta, Edmonton AB, Canada

**Background:** Over half of all heart disease and stroke are attributable to hypertension, which is associated with approximately 10% of direct medical costs globally. Clinical trial evidence has demonstrated that the benefits of pharmacist intervention, including education, consultation and/or prescribing, can help to reduce blood pressure—a recent Canadian trial found an 18.3 mmHg reduction in systolic blood pressure associated with pharmacist education and prescribing. The objective of this study was to evaluate the economic impact of such an intervention.

**Methods:** A Markov cost-effectiveness model was developed to extrapolate potential differences in long-term cardiovascular and renal disease outcomes, using Framingham risk equations and other published risk equations. A range of values for systolic blood pressure reduction were considered (7.6-18.3 mmHg), to reflect the range of potential interventions and available evidence. The model incorporated health outcomes, costs and quality of life to estimate an overall incremental cost-effectiveness ratio (ICER). Costs considered included direct medical costs as well as the costs associated with implementing the pharmacist intervention strategy. Probabilistic analysis to account for the joint uncertainty and costs and outcomes was conducted as were several scenario analyses.

**Results:** For a systolic blood pressure reduction of 18.3 mmHg, the estimated impact is 0.21 fewer cardiovascular events per person and, discounted at 5% per year: 0.3 additional life years, 0.4 additional quality-adjusted life years and \$6,364 cost-savings over a lifetime. Thus, the intervention is economically dominant, being both more effective and cost-saving relative to usual care.

**Discussion:** Comprehensive pharmacist care of hypertension, including patient education and prescribing, has the potential to offer both health benefits and cost savings to payers and as such, has important public health implications.

**158 Troches or orally dissolving tablets for delivery of pilocarpine in treatment of xerostomia (dry mouth)?**

Rose M Estafanos<sup>1</sup>, Esther T Lau<sup>2</sup>, Geoffrey Mitchell<sup>3</sup>, Hugh Senior<sup>3</sup>, Kathryn J Steadman<sup>1</sup>, <sup>1</sup>School of Pharmacy, University of Queensland, Brisbane, QLD, <sup>2</sup>School of Clinical Sciences, Queensland University of Technology, Brisbane, QLD, <sup>3</sup>School of Medicine, University of Queensland<sup>3</sup>, Brisbane, QLD

**Introduction:** Troches and orally dissolving tablets (ODTs) are dosage forms that can be compounded in pharmacies for buccal drug delivery. As part of a larger clinical trial into pilocarpine for treatment of xerostomia, the acceptability of compounded pilocarpine troches and ODTs was tested by healthy volunteers and patients who suffer from dry mouth of different aetiologies.

**Aims:** 1- To assess the taste acceptability of troches containing 5 mg pilocarpine and flavoured with 5 different flavours (Lemon, Chocolate, Raspberry, Mint and Non-flavour) to mask the bitter taste of pilocarpine. 2- To rate preference for troches vs ODTs as a dosage form for future treatment of dry mouth in Australia.

**Methods:** Ethics approval was obtained from the UQ Human Research Ethics Committee. A total of 34 healthy volunteers and 14 people who suffer from dry mouth were recruited. The dry mouth resulted from various aetiologies: head and neck cancer (6), Sjogren's syndrome (3), medication-induced (2), and non-identified reason (2). Participants tasted 5 different flavoured medicated troches by sucking each for no more than 10 seconds (to minimise pilocarpine absorption) and rating the relative acceptability. Participants then sucked a non-medicated troche followed by a non-medicated ODT, both flavoured the same, and rated their preference of the given dosage forms.

**Results:** Healthy volunteers preferred lemon flavour (35%) followed by raspberry flavour (20%). For the xerostomic patients, raspberry was preferred (31%) followed by chocolate (23%) and lemon (23%). ODTs were preferred rather than troches by 71% of the healthy volunteers and all of the xerostomic patients (100%). ODTs were preferred because of their small size along with quick and easy dissolution in the mouth without the need of water.

**Discussion:** ODTs can be easily be prepared in a compounding pharmacy that is equipped with an oven and a specially-designed mould. The preferred dosage form – raspberry flavoured pilocarpine ODTs – will be tested for effectiveness in a clinical trial using a N-of-1 trial design.

**159 Lipophilic Salts of Small Molecule Kinase Inhibitors for Increased Oral Bioavailability Using Lipid Formulations**

Hywel D Williams<sup>1</sup>, Leigh Ford<sup>2</sup>, Kristian Tangso<sup>3</sup>, Annabel Igonnin<sup>4</sup>, Hassan Benameur<sup>4</sup>, Colin W Pouton<sup>3</sup>, Peter J Scammells<sup>2</sup>, Christopher JH Porter<sup>3</sup>, <sup>1</sup>Lonza R&D, <sup>2</sup>Medicinal Chemistry, <sup>3</sup>Drug Delivery Disposition Dynamics at Monash Institute of Pharmaceutical Sciences, Melbourne, VIC, Australia, <sup>4</sup>Lonza Pharma Sciences, Strasbourg, France

**Introduction:** The purpose of this study was to increase the oral exposure of high log P (>5) small molecule kinase inhibitors by (i) transformation into lipophilic salts and (ii) delivery in lipid formulations.

**Methods:** Docusate salts of cabozantinib and ceritinib were prepared in-house. The solubility of the docusate salts was evaluated in several lipidic excipients and model self-emulsifying lipid formulations (SEDDS). Cabozantinib docusate containing SEDDS and crystalline cabozantinib free base were orally dosed to fasted rats at 25 mg/kg, and absolute bioavailability determined based on an IV treatment arm (at 5 mg/kg). Solubilization by the SEDDS formulas in an *in vitro* gastric–small intestine model was also evaluated.

**Discussion:** Docusate salts were significantly more soluble in lipidic excipients, with 50–100 mg/g (free base equivalents) concentrations achieved in at least three excipients (see Figure insert). The high lipid solubility of the lipophilic salt forms allowed at least 100 mg/g loading in model SEDDS formulations—a 4-fold enhancement in loading over the free base forms. Cabozantinib docusate containing SEDDS resulted in higher drug solubilization *in vitro* at pH 2 and pH 6.5 when compared to crystalline free base. In fasted rats, cabozantinib free base oral bioavailability was 47.2±10.9%. Bioavailability increased ~2-fold to 83.4±3.3% when dosed as the lipophilic salts in the SEDDS (see Figure insert), confirming that a combined lipophilic salt–SEDDS approach was effective in increasing cabozantinib absorption. Overall, the data suggest that for kinase inhibitors demonstrating challenging physicochemical properties, conversion to lipophilic salts can unlock the well-known absorption enhancing benefits of lipid formulations.

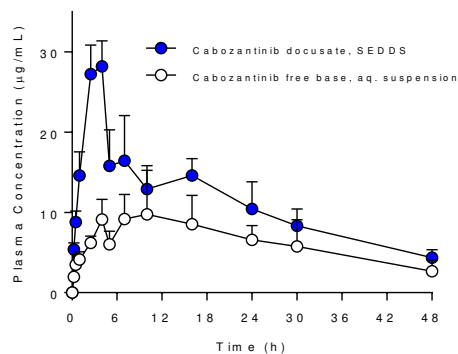

### 160 Triglyceride-mimetic prodrugs of testosterone significantly enhance lymphatic transport and oral bioavailability

Tim Quach<sup>1,2,3</sup>, S. Fern Lim<sup>1,2,3</sup>, Sifei Han<sup>1,3</sup>, Luojuan Hu<sup>1,3</sup>, Jamie S. Simpson<sup>1,2</sup>, Natalie L. Trevaskis<sup>1</sup>, Christopher J. H. Porter<sup>1,3</sup>, Drug Deliv, Disp and Dynamics<sup>1</sup>, Med Chem<sup>2</sup>, The ARC Centre of Excellence for Conv Bio-Nano Science<sup>3</sup> MIPS, Monash Uni (Parkville), Melbourne, VIC

**Introduction:** After oral administration, drug metabolism on first-pass through the liver may be a significant barrier to clinical success. High first-pass metabolism limits oral bioavailability for marketed drugs such as testosterone (TST) and likely limits the progression of many experimental drug candidates. One means of circumventing this problem is to promote drug transport through the lymphatic system via association with endogenous lymph lipoproteins. The intestinal lymph drains from the intestine, via the thoracic duct, directly into the major veins in the neck, thus bypassing the liver. The current study describes a triglyceride (TG) mimetic prodrug strategy to increase lymphatic transport and bioavailability of TST. The design strategy was based on the realisation that following oral ingestion, dietary TG is very efficiently transported into the intestinal lymphatics via incorporation into lipoproteins.

**Aims:** To evaluate the effectiveness of different self-immolative (SI) groups in facilitating the release of parent drug from TG mimetic prodrugs of TST following transport via the lymphatics.

**Methods:** Prodrugs were prepared using standard methods, including those previously reported by our group (Hu et al, 2016). Lymphatic transport and bioavailability studies were conducted in mesenteric lymph duct or carotid artery cannulated rats, respectively. Rats received the TST prodrugs via intraduodenal infusion (lymph) or oral gavage (bioavailability).

**Results.** TG prodrugs of TST were transported into the lymphatics with varying efficiency (2.8-28.1% of the dose, vs <0.1% for TST), depending on the linker. Incorporation of SI groups facilitated TST release from the prodrugs, leading to marked enhancement in oral bioavailability (up to 90-fold) compared to the marketed product, TST undecanoate.

**Discussion:** TG mimetic prodrugs successfully increased the lymphatic transport and systemic exposure of TST following oral administration. Prodrugs with linkers that promoted stability in the GI tract maximally enhanced lymphatic transport while those containing a labile SI group gave the highest increases in systemic exposure.

Hu L et al (2016) *Angew Chem Int Ed* 55:13700-13705.

### 161 Characterising and predicting the *in vivo* kinetics of therapeutic mesenchymal stem cells and their secretome

Haolu Wang<sup>1</sup>, Xiaowen Liang<sup>1</sup>, Anastasia Brooks<sup>1,2</sup>, Michael S. Roberts<sup>1</sup>, <sup>1</sup>Diamantina Institute, The University of Queensland, Brisbane, QLD, Australia, <sup>2</sup>School of Biomedical Sciences, The University of Queensland, Brisbane, QLD, Australia

Cell therapy has emerged as an evolutionary therapeutic force especially for diseases not curable by traditional therapeutics. However, the success of many cell therapies has been grossly impeded by the poorly-understood cell-tissue interactions and ill-defined cell pharmacokinetics in the body. Mesenchymal stem cells (MSCs) and the immunomodulatory cytokines produced by MSCs have considerable potential for the treatment of for many debilitating diseases including liver cirrhosis, diabetes, spinal cord injury and myocardial infarction. Here, we developed the first physiologically-based kinetic model of therapeutic MSCs, and two-compartment pharmacokinetic model of MSC secretome (Interleukin 6 and Interleukin 8). The utility of these models was examined across species and administration routes by extrapolation of this model to rats and humans, as well as to intra-hepatic arterial injection. The clinical application of this model was also tested with data obtained from stem cell-based therapies to patients with liver cirrhosis. Our model successfully characterised the *in vivo* kinetics of therapeutic MSCs and their secretome. This is the first study accurately characterises and predicts the *in vivo* kinetics of therapeutic mesenchymal stem cells and their secretome. It provides the optimised dosage, route of administration, and targeting strategies for MSC-based therapy to achieve the maximum effectiveness with the lowest risk. By adapting specific parameters, this model can be easily applied to other types of therapeutic cells for designing standardised treatment protocols.

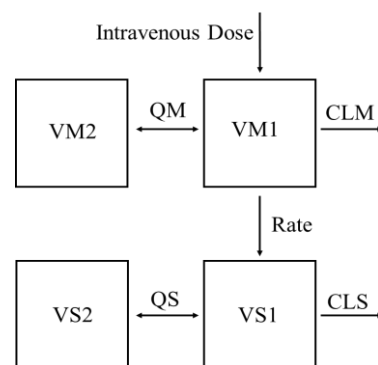

### 162 Permeation of quercetin through the human epidermis

Azadeh Alinaghi<sup>1</sup>, Ana Macedo<sup>1</sup>, Pauline Dréan<sup>2</sup>, Amy Holmes<sup>1</sup>, Ahmed Abdalla<sup>1</sup>, H. Srikanth Cheruvu<sup>1</sup>, Michael S. Roberts<sup>1,3</sup>  
<sup>1</sup>Therapeutic Research Centre, School of Pharmacy and Medical Sciences, University of South Australia, Basil Hetzel Institute for Translational Health Research, Adelaide, SA; <sup>2</sup>University of Rennes 1, Rennes, France, <sup>3</sup>Therapeutics Research Centre, Diamantina Institute, University of Queensland, Translation Research Institute, Brisbane, QLD, Australia

**Introduction:** Quercetin is a naturally occurring antioxidant, which has the potential to treat actinic keratosis but also has a poorly defined human skin permeability.

**Aim:** In this work, we designed and tested a range of formulations that may facilitate the human skin permeation of quercetin.

**Methods:** Various topical microemulsions and liquid formulations were designed using a series of skin permeation enhancers that varied in their 3D relative differences between formulation, quercetin and stratum corneum solubility parameters. Human epidermal membranes were prepared from excised human skin and mounted in Franz diffusion cells to assess the epidermal permeation of quercetin (1 mg/ml) from the formulations over time at 32°C. The skin permeation enhancers included the fatty acids and esters (oleic acid, OA; isopropyl myristate, IPM; Capryol 90, Cap), phospholipids (Phospholipon 90G, PhG), hydrogen bond solvent (dimethyl sulfoxide, DMSO) and propanol (Prop).

**Result:** Fig. 1 shows that the permeation of quercetin through human epidermal membranes varied greatly with the topical formulation used and was not well described by solubility parameter differences. The most and least effective formulations were microemulsions containing oleic acid and Capryol 90, respectively.

**Discussion:** This work suggests that solubility parameters are limited in their ability to describe the permeation enhancement of quercetin through human epidermis by various formulations. A more likely explanation for the formulation induced human epidermal permeation enhancement are specific molecular interactions between the permeation enhancers and molecules associated with the stratum corneum barrier, such as the intercellular lipids.

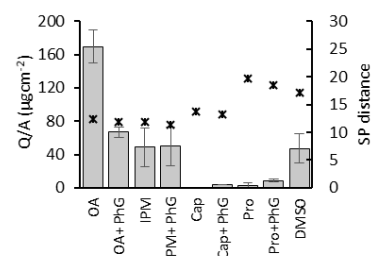

### 163 Evaluation of optimised piperacillin plus tobramycin combination dosage regimens against *Pseudomonas aeruginosa* (Pa) for patients with altered pharmacokinetics via the hollow fibre infection model and mechanism-based modelling

Rajbharan Yadav<sup>1</sup>, Kate E. Rogers<sup>1,2</sup>, Phillip J. Bergen<sup>2</sup>, Jürgen B. Bulitta<sup>3</sup>, Carl M. J. Kirkpatrick<sup>2</sup>, Steven C. Wallis<sup>4</sup>, David L. Paterson<sup>5</sup>, Roger L. Nation<sup>1</sup>, Jeffrey Lipman<sup>4</sup>, Jason A. Roberts<sup>4</sup> and Cornelia B. Landersdorfer<sup>1,2</sup>. Drug Deliv, Dispos and Dynamics<sup>1</sup>, Centre for Medicine Use and Safety<sup>2</sup>, Monash Univ, Parkville, VIC, Australia; Dept of Pharmaceutics, University of Florida<sup>3</sup>, Orlando, FL, USA; Burns, Trauma Crit Care Res Centre<sup>4</sup>, Cent for Clin Res<sup>5</sup>, Univ of Queensland, Brisbane, Australia.

**Introduction.** Augmented renal clearance (ARC) in critically-ill patients can result in suboptimal drug exposures and potential treatment failure.

**Aims.** This study aimed to design and evaluate optimised combination dosage regimens of piperacillin (PIP) and tobramycin (TOB) against a Pa clinical isolate in the hollow fibre infection model (HFIM) for patients with ARC.

**Methods.** We studied clinically relevant PIP and TOB concentrations, alone and in combinations in *in vitro* static concentration time-kills (SCTK), against a Pa clinical isolate at two inocula (10<sup>5.7</sup> and 10<sup>7.5</sup> cfu/mL) over 72h. We optimised PIP + TOB regimens via mechanism-based modelling (MBM) of SCTK data. The effect of optimised PIP (4g q4h, 0.5h infusion) plus TOB (5 mg/kg q24h, 7 mg/kg q24h and 10 mg/kg q48h as 0.5h infusions) regimens on bacterial killing and regrowth was evaluated in the HFIM for patients with ARC (creatinine clearance 250 mL/min) over 8 days.

**Results.** PIP monotherapy (4g every 4h) in the HFIM provided 2.4 log<sub>10</sub> killing at 13h followed by rapid regrowth at 24h with resistance emergence. TOB monotherapies displayed rapid initial killing (≥5 log<sub>10</sub> at 13h) followed by extensive regrowth. The PIP + TOB dosage regimens were synergistic and provided ≥5 log<sub>10</sub> killing with resistance suppression over 8 days in the HFIM.

**Discussion.** Optimised PIP + TOB regimens provided significant bacterial killing and suppressed resistance emergence as predicted by MBM, and therefore translated well from SCTK to the dynamic HFIM. This highlights the utility of MBM to select optimised regimens that maximise bacterial killing and minimise resistance emergence against Pa, an especially important finding given that Pa can rapidly develop MDR. Thus, these regimens are highly promising for effective and early treatment, even in the near-worst case scenario of ARC.

**164 CMF-019, the first G protein biased small molecule apelin agonist, is a vasodilator and positive inotrope in vivo**  
 Cai Read<sup>1</sup>, Christopher Fitzpatrick<sup>2</sup>, Peiran Yang<sup>1</sup>, Rhoda E. Kuc<sup>1</sup>, Duamene Nyimanu<sup>1</sup>, Janet J. Maguire<sup>1</sup>, Robert Glen<sup>3</sup>, Richard Foster<sup>2</sup>, Anthony P. Davenport<sup>1</sup>, <sup>1</sup>EMIT, Univ of Cambridge, Cambridge, UK, <sup>2</sup>Chem Biol and Med Chem, Univ of Leeds, Leeds, UK, <sup>3</sup>Ctr for Mol Info, Univ of Cambridge, Cambridge, UK

**Introduction:** Pulmonary arterial hypertension (PAH) has poor prognosis and is associated with pulmonary vasoconstriction and right ventricular failure. Apelin, a vasodilator and inotrope, is a promising target but lacks bioavailability, is limited by half-life and internalises the receptor through  $\beta$ -arrestin signalling. CMF-019 ((S)-3-[1-(1-ethyl-propyl)-2-thiophen-2-ylmethyl-1H-benzoimidazole-5-carbonyl]-amino-5-methyl-hexanoic acid), a biased small molecule apelin agonist, could overcome these issues (Read *et al.* 2016).

**Aims:** To further characterise CMF-019 as an apelin mimetic *in vivo* and as a potential therapeutic against PAH.

**Methods:** CMF-019 was synthesised (Tocris). Male Sprague-Dawley rats (271±3g, n=17) induced (3%) and maintained (1.5%) under anaesthesia with inhaled isoflurane carried by oxygen (1.5L/min) were catheterised in the left ventricle and femoral artery with pressure-volume catheters. CMF-019 (1mg/kg) was injected iv. Male Sprague-Dawley rats (209±2g, n=35) received a sc injection of monocrotaline (MCT, 60mg/kg) or saline and thereafter, daily ip injections of CMF-019 (10mg/kg) or saline. After 21 days, left and right ventricles were catheterised (as above) and the Fulton index recorded.

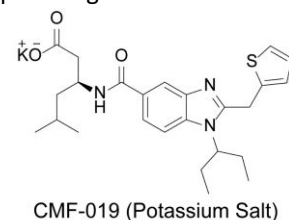

**Results:** Acutely, CMF-019 induced arterial dilatation (5.96±1.15mmHg, n=8) and cardiac contractility (458±51mmHg/s, n=8) without receptor desensitisation. Chronically, CMF-019 did not reduce the Fulton index or right ventricular pressure of MCT compared to saline treated animals.

**Discussion:** CMF-019, induced dilatation and inotropy *in vivo* and preliminary studies using human pulmonary arterial endothelial cells have suggested disease modifying potential. However, there was insufficient target engagement chronically to alleviate induced PAH. In conclusion, CMF-019 provides a starting point for the rational design of novel biased apelin analogues but more work is required to assess its PK properties for chronic administration.

Read C. *et al.* (2016). *Biochem Pharmacol.* 166:63-72

### 165 Polymer precipitation inhibitors can maintain drug supersaturation and increase *in vivo* absorption from lipid-based formulations

Estelle Suys<sup>1,2</sup>, David K. Chalmers<sup>3</sup>, Colin W. Pouton<sup>1</sup>, Christopher J.H. Porter<sup>1,2</sup>, <sup>1</sup>Drug Delivery, Disposition and Dynamics <sup>2</sup>ARC Centre of Excellence in Convergent Bio-Nano Science and Technology, <sup>3</sup>Medicinal Chemistry, Monash University, Melbourne, VIC, Australia

**Introduction:** Lipid-based formulations (LBFs) have emerged as a promising formulation strategy to overcome the issue of solubility-limited absorption, thereby improving the oral bioavailability of poorly water-soluble drugs (PWSDs). After oral dosing, supersaturation often arises with the potential for drug precipitation. To stabilize the metastable supersaturated state, polymer precipitation inhibitors (PPIs) may be added to LBFs to inhibit drug precipitation, potentially resulting in increased drug absorption.

**Aims:** The current project is exploring the solubility-supersaturation-absorption relationship when using PPIs in LBFs, by measuring drug flux in an *in vivo* experimental model.

**Methods:** A coupled *in vitro* digestion - isolated rat jejunum model, has been employed to evaluate in real time the impact of PPIs on drug flux. Fenofibrate and saquinavir were chosen as model PWSDs.

**Results:** Addition of selected PPIs prolonged supersaturation and led to increases in fenofibrate absorption of up to ~ 4-fold. Reasonable correlation was evident between the degree of supersaturation and drug flux suggesting that increases in the intraluminal free drug fraction were driving increased absorption.

**Discussion:** This work demonstrates the utility of the coupled *in vitro* digestion-*in vivo* absorption model in developing a better understanding of drug absorption from polymer-containing LBFs. The data suggest that PPIs can support prolonged drug supersaturation and that this results in improved absorptive drug flux *in vivo*.

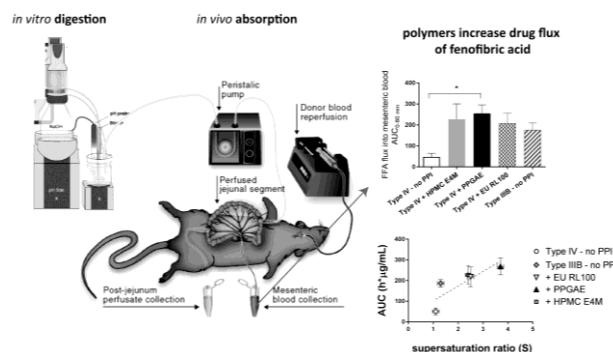

**166 Pulsed magnetic stimulation for persistent post-prostatectomy stress urinary incontinence: A pilot study**

Renly Lim<sup>1</sup>, Men Long Liong<sup>2</sup>, Kah Hay Yuen<sup>1</sup>, <sup>1</sup>School of Pharmaceutical Sciences, Universiti Sains Malaysia, Penang, Malaysia, <sup>2</sup>Department of Urology, Island Hospital, Penang, Malaysia

**Introduction:** Stress urinary incontinence following radical prostatectomy is a significant side-effect which severely impairs quality of life. The first-line non-surgical treatment for post-prostatectomy stress urinary incontinence is the pelvic floor muscle training. However, treatment regimens are not standardised and success rates are modest. Pulsed magnetic stimulation is a non-surgical method which increases the pelvic floor muscle strength and endurance through automatic repetitive contractions.

**Aims:** To evaluate the efficacy of the pulsed magnetic stimulation in patients with persistent post-prostatectomy stress urinary incontinence.

**Methods:** Patients with persistent stress urinary incontinence (more than 12 months) after radical prostatectomy were recruited from the urology department, Island Hospital, Malaysia. The treatment regimen involved two sessions per week for eight weeks (16 sessions of 25 minutes each). The device uses a pulsed magnetic stimulation repetition cycle of 50 Hz in an 8 seconds on-4 seconds off pulsing manner. The primary outcome measure was the International Consultation on Incontinence Questionnaire for Urinary Incontinence-Short Form (ICIQ-UI SF) (range 0-21). The secondary outcome measures included the International Consultation on Incontinence Questionnaire-Lower Urinary Tract Symptoms Quality of Life (ICIQ-LUTSqol) (range 19-76) and the Patient Global Impression of Improvement (PGI-I). Evaluation was conducted pre- and post-treatment.

**Results:** A total of fifteen patients were enrolled (mean age 65, range 57-74). There was a significant reduction in the mean ICIQ-UI SF score from 13.5±0.9 to 9.1±0.8 ( $p<0.001$ ). Similarly, there was a significant reduction in the ICIQ-LUTSqol score from 44.1±2.2 to 35.1±1.9,  $p=0.002$ . Nine of fifteen patients (60%) felt that their condition was "very much better" or "much better" as measured using the PGI-I. No side effects were observed.

**Discussion:** Among patients with persistent post-prostatectomy stress urinary incontinence, our preliminary results suggested that eight weeks of pulsed magnetic stimulation improved symptoms of incontinence significantly. A large randomized-controlled trial is required to confirm the findings of our pilot study.

**167 Pharmacological effects of a jungle ginger on rat prostatic smooth muscle**

Eunice NN Su<sup>1,3</sup>, Jamie S Simpson<sup>2</sup>, Philip Thompson<sup>2</sup>, Sabatino Ventura<sup>1</sup>, Drug Discovery Biology<sup>1</sup> and Medicinal Chemistry<sup>2</sup>, Monash Institute of Pharmaceutical Sciences, Monash University, Parkville, VIC, Australia. Sarawak Biodiversity Centre, Kuching, SWK, Malaysia<sup>3</sup>

**Introduction.** Jungle ginger has been traditionally used by Sarawak natives to treat urological disorders. Since drugs that relax prostatic smooth muscle are used to manage urinary symptoms associated with urological disorders.

**Aims.** To assess the pharmacological effects of a jungle ginger on prostate contractility and to isolate its bioactive components.

**Methods.** This is original work reporting the biological effects of jungle ginger on isolated rat prostate contractility. Jungle ginger rhizome, roots, leaves and stem were harvested from Sarawak. Extracts of dried and ground plant materials were extracted using water at room temperature. Activity of these extracts was evaluated pharmacologically by assessing their effects on contractions of isolated rat prostate gland maintained in a modified Krebs solution at 37°C and bubbled with carbogen gas. Nerve mediated contractions were evoked electrically (0.1-20 Hz, 0.5 ms pulse duration, 60 V) while direct muscle stimulation was achieved by application of the exogenously administered agonists. Pharmacological tools were used to identify mechanisms of action.

**Discussion.** Jungle ginger rhizome ( $p=0.0004$ ,  $n=6$ ), root ( $p<0.0001$ ,  $n=6$ ) and stem ( $p=0.0057$ ,  $n=6$ ) extract inhibited electrical field stimulation (EFS) induced contractions of rat prostatic smooth muscle, while leaf extract did not exhibit bioactivity ( $p=0.0988$ ,  $n=6$ ). Contractions mediated by exogenous administration of noradrenaline (1 nM-1 mM,  $n=6$ ), acetylcholine (1 nM-1 mM,  $n=6$ ) or ATP (0.3  $\mu$ M-1 mM,  $n=6$ ) were not inhibited by rhizome extract. Tyramine (10 nM-0.1 nM) induced contractions were also not effected by the rhizome extract ( $n=4$ ). EFS-induced contractions were still attenuated by the rhizome extract in the presence of prazosin (300 nM,  $n=6$ ), suramin (30 nM,  $n=6$ ), yohimbine (1  $\mu$ M,  $n=6$ ), idazoxan (1  $\mu$ M,  $n=6$ ), propranolol (1  $\mu$ M,  $n=6$ ), atropine (1  $\mu$ M,  $n=6$ ), methysergide (1  $\mu$ M,  $n=6$ ), mepyramine (1  $\mu$ M,  $n=6$ ), hexamethonium (10  $\mu$ M,  $n=6$ ), desipramine (100 nM,  $n=6$ ), 8-phenyltheophylline (10  $\mu$ M,  $n=6$ ), and AH6809 (10  $\mu$ M,  $n=6$ ). Jungle ginger rhizome, stem and root extracts inhibit contractility of rat prostatic smooth muscle by an indirect prejunctional mechanism that inhibits exocytotic release of neurotransmitter.

**168 Post-hospital changes in medication regimen complexity and potentially inappropriate medication use in older adults with chronic kidney disease**

W Tesfaye<sup>1</sup>, RL Castelino<sup>2</sup>, BC Wimmer<sup>1</sup>, C McKercher<sup>3</sup>, MD Jose<sup>1,3</sup>, STR Zaidi<sup>1</sup>, <sup>1</sup>University of Tasmania, Hobart, TAS, AU  
<sup>2</sup>The University of Sydney, Sydney, NSW, AU, <sup>3</sup>Menzies Institute for Medical Research, Hobart, TAS, AU

**Introduction:** Significant medication change related to hospitalisation is an important contributor to patient morbidity in chronic kidney disease (CKD). Little is known about the impact of such changes on medication regimen complexity and potentially inappropriate medications (PIMs) use in older adults with CKD.

**Aims:** To evaluate the impact of hospitalisation on medication regimen complexity and PIMs use in older adults with CKD.

**Methods:** Medical records of patients aged  $\geq 65$  years with a documented stage 3 and 4 CKD admitted to the study hospital during Jan-Jun, 2015 were reviewed. Data on age, sex, Charlson's comorbidity index (CCI), serum creatinine, eGFR, length of hospital stay (LOS) and use of drug administration aids (DAA) were collected. The medication regimen complexity index (MRCI) and medication appropriateness index (MAI) were used to compute medication regimen complexity and PIMs, respectively. Differences in the study variables were analysed using Wilcoxon signed rank test whereas a generalised linear model was used to determine association between study variables.

**Results:** A total of 100 patients were included. Mean age of participants was  $81.3 \pm 7.9$  years and most (75%) were men. The mean number of medications per patient was  $10.3 \pm 4.1$  at admission and  $10.4 \pm 3.9$  at discharge. There was a non-significant increase in MRCI from admission to discharge [ $27.7 \pm 11.4$  to  $29.2 \pm 11.8$ ]. A significant decline in the use of PIMs was observed at the time of discharge from the hospital (MAI of  $8.4 \pm 6.3$  vs.  $6.4 \pm 5.4$ ;  $p < 0.01$ ). Patients who stayed longer were likely to have a significantly higher change in MRCI after adjusting for the effect of age, sex, CCI, renal functions at admission, and use of DAA ( $\beta = 0.31$ , Std Err = 0.05,  $p < 0.01$ ).

**Discussion:** Despite the added medication regimen complexity, hospitalisation resulted in a significant reduction in PIMs in older adults with CKD. Moreover, longer hospitalisations have led to higher medication regimen complexity at discharge. This could pose concerns regarding medication adherence after patient discharge from hospital. Future studies should explore the determinants of the observed reduction in PIMs use and the increase in medication regimen complexity with prolonged hospital admission to optimise medication use in older adults with CKD.

**169 Effect of Rho-kinase inhibitors on contractility of porcine corpus cavernosum**

Amelia J Jack, Dr. Donna Sellers, Prof. Russ Chess-Williams, Centre for Urology Research, Bond University, Gold Coast, QLD, Australia

**Introduction:** The main oral pharmacotherapy available for erectile dysfunction (ED) are not effective for 32% of men (Eardley et al, 2010). As smooth muscle relaxation is a desired outcome of treatment, the RhoA/Rho-kinase (ROCK) pathway is under investigation as a novel target in the control of muscle tone in the corpus cavernosum, as previous research has shown a role for ROCK in maintaining the contractility of the corpus cavernosum in rodents (Chitale et al, 2001).

**Aim:** This study investigated the role of the ROCK signalling pathway in mediating smooth muscle tone in porcine corpus cavernosum.

**Methods:** Functional organ bath studies investigated the contractility of porcine corpus cavernosum in the absence and presence of the ROCK inhibitors Y-27632 ( $10 \mu\text{M}$ ) and GSK-269962 ( $100 \text{nM}$ ). Phenylephrine concentration-response curves determined maximum contraction and potency ( $p\text{EC}_{50}$ ) values. Student's t-test identified differences between tissue responses ( $p < 0.05$  = significant difference).

**Results:** Mean maximum contractions induced by phenylephrine were significantly decreased by  $75.2 \pm 3.6\%$  ( $p < 0.01$ ,  $n = 19$ ) by Y-27632 and  $36.6 \pm 5.2\%$  ( $p < 0.01$ ,  $n = 15$ ) by GSK-269962 compared to control. The potency of phenylephrine was reduced in the presence of Y-27632 ( $5.84 \pm 0.12$  vs.  $4.50 \pm 0.27$ , ( $p < 0.01$ ), and in the presence of GSK-269962 ( $5.85 \pm 0.17$  vs.  $5.18 \pm 0.16$ ,  $p < 0.01$ ).

**Discussion:** The ROCK signalling pathway is involved in mediating smooth muscle tone in porcine corpus cavernosum. Y-27632 produced a greater inhibitory effect on the contractions induced by phenylephrine than GSK-269962. Y-27632 also affected the potency of phenylephrine more than GSK-269962. This could be due to the non-selective action of Y-27632 on other kinases involved in smooth muscle tone. The ROCK signalling pathway may be a potential target molecule for development of alternative therapy, providing a new treatment option for ED.

Chitale K et al (2001) Nat Med 7:119-122.

Eardley I et al (2010) J Sex Med 7:524-540.

**170 The effects of aging on polarization in collagen sandwich-cultured hepatocytes**

Sun Woo Sophie Kang<sup>1,2</sup>, Dong Fu<sup>3</sup>, David G. Le Couteur<sup>1,2</sup> and Victoria C. Cogger<sup>1,2</sup>, <sup>1</sup>Aging and Alzheimers Institute, ANZAC Research Institute, Concord Clinical School/Sydney Medical School, Concord, NSW, Australia, <sup>2</sup>Charles Perkins Centre, University of Sydney, Sydney, NSW, Australia, <sup>3</sup>UNC Eshelman School of Pharmacy, University of North Carolina at Chapel Hill, NC, United States of America

**Introduction:** Hepatocytes have a unique polarized phenotype where apical domains of adjacent cells make up a tubular structure, known as bile canaliculus. This polarized morphology is important for hepatocyte function and viability. Loss of polarity can result in excessive accumulation of bile, toxins and metabolites that can lead to hepatocellular damage such as seen in drug-induced hepatotoxicity and liver diseases such as cholestasis, fibrosis and cirrhosis. Ageing is associated with increased susceptibility to impaired hepatic function, which can increase the risk of adverse drug reactions that are associated with hepatotoxicity and liver disease. However, the effect of ageing on hepatocyte polarization is unknown. Using collagen sandwich cultures of hepatocytes, we compared the reestablishment of hepatocyte polarization in isolated hepatocytes from young and old mice.

**Methods:** Hepatocytes were freshly isolated from young (3 months) and old (24 months) C57BL6 male mice and cultured in a collagen sandwich configuration. Polarization was assessed every 12 hours over 72 hours using lipid droplet staining and immunofluorescence of apical protein ATP-binding cassette sub-family B member 1 and tight junctional protein Zonula occludens-1. ATP levels were also quantified.

**Results:** Immunofluorescence revealed that hepatocytes from old mice polarized at a faster rate than young hepatocytes. Furthermore, there were significantly more and larger lipid droplets in the hepatocytes of old mice from the beginning of hepatocyte polarization. Lipid droplets remained large in old hepatocytes after 60 hours even after the formation of the bile canalicular network. In young mice, the reduction of lipid droplet numbers was evident after 24 hours. Polarization is an energy-dependent cellular process. ATP levels rapidly peaked within 24 hours in old hepatocytes whereas in young hepatocytes levels increased more slowly and peaked after 48 hours.

**Discussion:** Hepatocytes from old mice polarize and accumulate ATP more rapidly than young hepatocytes. These changes might contribute to age-related changes seen in hepatic function and susceptibility to drug-induced hepatotoxicity and liver diseases such as fatty liver.

**171 Human 5-HT<sub>3</sub>AC receptors are subtly different to 5-HT<sub>3</sub>A receptors**

Helen R. Irving<sup>1,2</sup>, Isaiah Abad<sup>1</sup>, Ray L. Fam<sup>1</sup>, Dan-Thanh Nguyen<sup>1</sup>, Cameron Nowell<sup>1</sup>, Phuc Trinh<sup>1</sup>, Jay Chakrabarti<sup>1</sup>, David T. Manallack<sup>3</sup>, Nor S. Yaakob<sup>1,4</sup>, Betty Exintaris<sup>1</sup>, <sup>1</sup>Drug Discovery Biology, Monash University, Melbourne, VIC, Australia, <sup>2</sup>La Trobe Institute for Molecular Science, La Trobe University, Bendigo, VIC, Australia, <sup>3</sup>Medicinal Chemistry, Monash University, Melbourne, VIC, Australia, <sup>4</sup>Drug & Herbal Research Centre, Universiti Kebangsaan Malaysia, Kuala Lumpur, Malaysia

**Introduction:** Five different subunits of the human 5-HT<sub>3</sub> receptor exist and these are present in both central and peripheral systems. 5-HT<sub>3</sub> receptor antagonists are used to treat diarrhea predominant-irritable bowel syndrome (IBS-D), chemotherapy induced nausea and vomiting (CINV) and depression. Receptor subunit arrangement is poorly understood and may contribute to differences in efficacy observed with the 5-HT<sub>3</sub> receptor antagonists.

**Aims:** To characterise the effect of the C subunit on 5-HT<sub>3</sub> receptor cell surface expression and function.

**Methods:** HEK293T cells were transiently transfected with constructs of 5-HT<sub>3</sub> receptor subunits containing fluorescent protein inserts between the 3<sup>rd</sup> and 4<sup>th</sup> transmembrane spanning region. Heteromers containing the C and A subunits were compared with homomers containing only the A or C subunit using whole cell patch clamp recording and super resolution microscopy.

**Results:** The A subunit is necessary to obtain functional AC subunits at the cell surface. Approximately 15-40% 5-HT<sub>3</sub> receptors at the cell surface are AC heteromers and the remainder are receptor homomers. Overall surface distribution of C subunits is in the range of 20-60% and A subunits is 40-80%. The surface distribution and co-localization is reflected in internal receptor assembly. The 5-HT<sub>3</sub> receptor C subunits contributed subtle changes in the electrophysiological responses to 5-HT. However, ondansetron exhibited reduced efficacy on the AC heteromer relative to the A homomer.

**Discussion:** C subunits interact with A subunits to form functional receptors. Patch-clamp experiments indicate that the presence of C subunits alters the efficacy of the clinically used antagonist ondansetron. The C subunit is widespread and found co-localized with the A subunit. Predisposition to forming 5-HT<sub>3</sub> receptor heteromers could contribute to poor responses observed in up to 40% of patients treated for CINV and IBS-D.

**172 Characterization of Na<sub>v</sub> Channels in Colon-Innervating Dorsal Root Ganglion Neurons in Mice**

Andelain Erickson<sup>1,3</sup>, Sonia Garcia-Caraballo<sup>1,3</sup>, Joel Castro<sup>1,3</sup>, Luke Grundy<sup>1,3</sup>, Grigori Rychkov<sup>1</sup>, Richard Lewis<sup>2</sup>, Irina Vetter<sup>2</sup>, Glenn King<sup>2</sup> and Stuart M. Brierley<sup>1,3</sup>, Discipline of Medicine, SAHMRI, University of Adelaide<sup>1</sup>, SA, AUSTRALIA, Institute for Molecular Bioscience, University of Queensland<sup>2</sup>, St Lucia, QLD, AUSTRALIA, Visceral Pain Research Group, Human Physiology, Flinders University<sup>3</sup>, Adelaide, SA, AUSTRALIA.

Chronic visceral pain is a poorly managed symptom of functional and inflammatory gastrointestinal disorders and there is a lack of analgesics that are efficacious without gastrointestinal side effects. Voltage-gated sodium (Na<sub>v</sub>) channels regulate action potential generation and cell membrane excitability in sensory neurons, and they are implicated in several pain or loss-of-pain phenotypes in humans, which has inspired investigation into the therapeutic potential of Na<sub>v</sub> channel modulation. In this study, we show that Na<sub>v</sub> channels and their auxiliary β-subunits are abundantly expressed in dorsal root ganglia (DRG) neurons at thoracolumbar (TL) and lumbosacral (LS) levels from C57BL/6J mice, and heterogeneously expressed in colon-innervating DRG neurons. Using retrograde labeling and whole-cell patch clamp electrophysiology, we found that colonic TL and LS neurons exhibited comparable peak sodium current densities (TL: -894 pA/pF, n = 23; LS: -883 pA/pF, n = 14), however, colonic TL neurons were significantly less excitable compared to colonic LS neurons (rheobase: TL: 183 pA, n = 32; LS: 85 pA, n = 22. p = 0.0143). The Na<sub>v</sub> channel blocker tetrodotoxin (TTX, 100 nM) significantly increased the minimum current required to fire an action potential in colonic TL and LS neurons, however, sodium current densities in colonic TL neurons were less affected by TTX compared to colonic LS neurons (TL: 50% reduction, n = 14; LS: 70% reduction, n = 8).

In conclusion, voltage-gated sodium channels and auxiliary β subunits are highly abundant in whole DRG and colonic DRG from T10–S1 spinal levels. However, TTX-S channels may have differing contributions to colonic DRG neurons innervating the thoracolumbar versus lumbosacral regions, which may underlie their differing functions.

**173 Histamine receptor (Hrh) subtypes mediate bladder afferent sensitivity in mice**

Ashlee Caldwell<sup>1</sup>, Luke Grundy<sup>1,2</sup>, Andelain Erickson<sup>1</sup>, Grigori Rychkov<sup>2</sup>, Stuart Brierley<sup>1,2</sup>. Dept of Medicine, Univ of Adelaide<sup>1</sup>, Adelaide, SA; Dept of Hum Physiol, Flinders Univ<sup>2</sup>, Bedford Park, SA.

**Introduction:** Pelvic pain conditions such as overactive bladder syndrome and interstitial cystitis are associated with enhanced bladder sensation, leading to the symptoms of frequency, urgency and pain. Histamine, released from activated mast cells, is a key mediator of neurogenic inflammation and pain in the bladder and other visceral organs. However, the exact role and distribution of histamine receptor subtypes (Hrh1-4) in bladder sensory structures is unknown.

**Aims:** To determine the expression and function of histamine receptors in bladder sensory structures.

**Methods:** RT-PCR was performed on primary urothelial cells and mucosal and detrusor layers of mouse bladders. Retrogradely labelled bladder DRG neurons from mice were isolated and dissociated for single-cell RT-PCR and calcium imaging. *Ex-vivo* bladder afferent recordings determined bladder mechanosensitivity.

**Results:** RT-PCR revealed mRNA expression of Hrh1-3 in dissociated urothelial cells, and 10-fold higher expression in bladder mucosal and detrusor tissue. Hrh4 mRNA expression was 1000-fold lower in both cells and tissues. Single cell PCR data identified Hrh1 mRNA expression in 29% of bladder afferent neurons whilst histamine (100μM) induced significant calcium transients in 18% of bladder DRG neurons. Histamine (300μM) perfused into the bladder lumen induced mechanical hypersensitivity to bladder distension versus saline (p<0.01, n=6) which was attenuated by Hrh1 antagonist pyrilamine (100uM) and completely abolished by combined Hrh1 and Hrh4 antagonists.

**Discussion:** Histamine receptors are present and functional in bladder sensory structures, and their activation is able to induce calcium transients in isolated bladder neurons and enhance bladder mechanosensitivity to distension. This work provides valuable insight into the action of histamine, and the role of histamine receptors in the bladder, unravelling potential mechanisms of pelvic pain pathology.

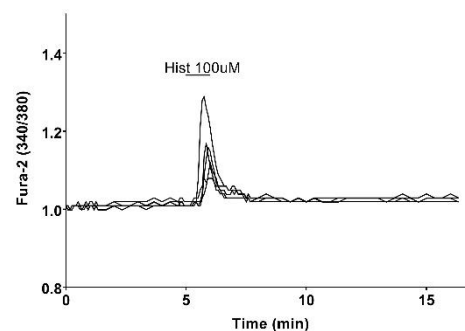

**174 Morphine dosing affects development of antinociceptive tolerance and motor behaviour**

Alok K Paul<sup>1</sup>, Nuri Gueven<sup>1</sup>, Nikolas Dietis<sup>1,2</sup>. Division of Pharmacy, School of Medicine, University of Tasmania<sup>1</sup>, Hobart, TAS, Australia; Medical School, University of Cyprus<sup>2</sup>, Nicosia, Cyprus.

**Introduction.** Clinical development of antinociceptive tolerance after repeated administration morphine limits its chronic use. Despite growing knowledge about the molecular mechanisms of morphine tolerance, we know little about the influence of dosage regimen in its development.

**Aims.** We hypothesized that morphine dose, as well as dose increments, contribute to tolerance development. In addition, morphine-induced behavioural changes also might follow similar pattern of antinociception and tolerance.

**Methods.** Four groups of male Sprague Dawley rats received different daily doses of intermittent subcutaneous morphine for 14 days. After the development of antinociceptive tolerance, different increments of morphine doses were administered until tolerance redeveloped (Group A: 2.5 (b.i.d.) → 5 → 10 mg/kg/day, Group B: 5 (b.i.d.) → 10 mg/kg/day, Group C: 5 (b.i.d.) → 15 mg/kg/day and Group D: 10 (b.i.d.) → 20 mg/kg/day). Antinociceptive responses were measured daily by tail-flick and hot-plate assays pre-treatment and at various post-treatment time-points. Motor behavioural effects were also measured using automated open-field paradigm and visual observations.

**Results.** Animals treated with lower starting-doses of morphine developed antinociceptive tolerance faster than those started on higher doses. Higher starting-doses and higher dose-increments after tolerance development resulted in more sustained antinociception and delayed the re-development of tolerance. These results were replicated by both antinociceptive assays and are therefore not assay-specific. The kinetics of morphine-induced motor suppression and desensitization were similar to those of antinociception and antinociceptive-tolerance respectively.

**Discussion.** These results suggest that morphine dosing regimen in rats significantly influences the manifestation of antinociceptive tolerance and the total antinociception (Paul et al., 2017). Our results also indicate that repetitive morphine dosing leads to desensitization of motor suppression in all major motor-behavioural parameters and manifests desensitization in conjunction with antinociceptive tolerance. Therefore, our results highlight that an optimized morphine dosing strategies can delay antinociceptive tolerance and reduce behavioural adverse effects.

Paul AK et al (2017) *Neuropharmacology* 121:158-166

**175 Increased osmotic pressure promotes glioblastoma invasiveness**

Wenjun Pu, Samira Khabbazi, Nan Xie, Marie-Odile Parat, School of Pharmacy, the University of Queensland<sup>1</sup>, Brisbane, QLD, Australia

**Introduction:** Both hydrostatic and osmotic pressures are altered in the tumour microenvironment. Glioblastoma (GBM) is a brain tumour with high invasiveness and poor prognosis. We hypothesized that higher osmotic pressure regulates glioblastoma (GBM) invasiveness. Better understanding the molecular and cellular mechanisms of how increased pressure promotes GBM invasiveness may help to develop innovative therapeutic approaches.

**Aims:** To evaluate the effect of osmotic pressure on GBM invasive potential.

**Methods:** The osmotic pressure of GBM cell culture medium was adjusted using sodium chloride or water. Cells were incubated in serum-free medium of various osmolality (from 260 to 440 mOsm) for 48 hours. Cell viability was tested using the MTT assay. The proteolytic profile and epithelial–mesenchymal transition (EMT) were investigated using zymography and real-time qPCR. The EMT markers assessed were snail-1, slug, twist, vimentin and N-cadherin. Invasion was investigated *in vitro* using Transwell™ inserts coated with basement membrane-like protein.

**Results:** In response to osmotic stress, GBM cell lines U87 and U251 upregulated the expression of urokinase-type plasminogen activator (uPA) and matrix metalloproteinases (MMPs) well as some of the EMT markers tested.

**Discussion:** GBM respond to osmotic pressure by increasing matrix degrading enzyme production, and adopting a gene expression phenotype reminiscent of EMT.

176 Discovering methyllycaconitine analogues specific for  $\alpha 4 \beta 2$  over  $\alpha 7$  nAChR subtypes

Taima Qudah<sup>1</sup>, Ryan Gallagher<sup>2</sup>, Nathan Absalom<sup>1</sup>, Thomas Balle<sup>1</sup>, Malcolm McLeod<sup>2</sup>, Mary Chebib<sup>1</sup>, <sup>1</sup> Faculty of Pharmacy, The University of Sydney, NSW, <sup>2</sup>Research School of Chemistry, The Australian National University, ACT, Australia

**Introduction:** Nicotinic Acetylcholine Receptors (nAChRs) are pentameric ligand-gated ion channels where the  $\alpha 7$  and  $\alpha 4\beta 2$  subtypes are the most predominant in the brain. The  $\alpha 4\beta 2$  nAChR is known to exist in two functional isoforms with different ACh-activation properties, namely the  $(\alpha 4)_2(\beta 2)_3$  and  $(\alpha 4)_3(\beta 2)_2$  receptor that differ by the presence of an additional agonist binding site at the  $\alpha 4$ - $\alpha 4$  interface on  $(\alpha 4)_3(\beta 2)_2$  receptors. Methyllycaconitine (MLA) is a natural toxic potent antagonist that competes with ACh at the same binding site. MLA is 1000-fold more selective for  $\alpha 7$  than at  $\alpha 4\beta 2$  despite high potency at both receptors. Identifying selective  $\alpha 4\beta 2$  nAChR antagonists have significant therapeutic potential and contribute to understanding the physiological roles of these subtypes *in vivo*.

**Hypothesis:** we hypothesize that the AE succinimide component of MLA has higher selectivity at the  $\alpha 4$ - $\alpha 4$  in  $(\alpha 4)_3(\beta 2)_2$  over the  $\alpha 7$ - $\alpha 7$  interface.

**Method:** we synthesized MLA analogues and screened these by co-applying 10  $\mu\text{M}$  of each compound with 1 mM ACh for  $(\alpha 4)_3(\beta 2)_2$  and  $\alpha 7$  and 100  $\mu\text{M}$  ACh  $(\alpha 4)_2(\beta 2)_3$  on human recombinant receptors expressed in *Xenopus* oocytes using the two-electrode voltage clamp techniques.

**Result:** we identified three analogues (BA09, BA11 and BA12) that inhibited the ACh induced current at  $(\alpha 4)_3(\beta 2)_2$  by 80%, 82% and 70%, respectively with no effect at the  $\alpha 7$  subtype (e.g BA09 in Figure 1). The same analogues only inhibited the ACh evoked current by 35%, 30% and 33% at  $(\alpha 4)_2(\beta 2)_3$  respectively. Based on these results, we identified lead molecules that distinguish between  $\alpha 4\beta 2$  and  $\alpha 7$  receptors.

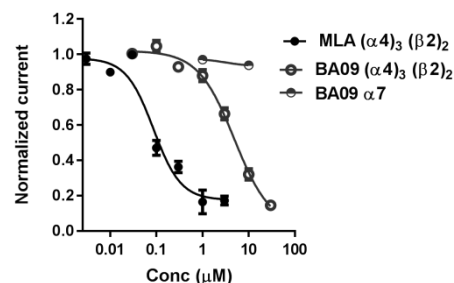

Figure 1. Inhibition of  $(\alpha 4)_3(\beta 2)_2$  receptors by MLA and BA09, and  $\alpha 7$  receptors by BA09.

177 Inhibition of  $\alpha 5\beta 1$  with the clinically validated small peptide ATN-161 is neuroprotective and functionally restorative in experimental stroke

Danielle N Edwards<sup>1</sup>, Katie Salmeron<sup>1</sup>, Justin F Fraser<sup>1,2,3,4</sup>, Gregory J Bix<sup>3</sup>, <sup>1</sup>Neuroscience, University of Kentucky, Lexington, KY, USA, <sup>2</sup>Neurosurgery, University of Kentucky, Lexington, KY, USA, <sup>3</sup>Neurology, University of Kentucky, Lexington, KY, USA, <sup>4</sup>Radiology, University of Kentucky<sup>4</sup>, Lexington, KY, USA

**Introduction:** Stroke is the second leading cause of death and the leading cause of long-term disability worldwide. Blood-brain barrier (BBB) dysfunction exacerbates reperfusion-induced injury after recanalization in ischemic stroke. Endothelial cell integrin receptors, specifically the  $\beta 1$  subtype, play a direct role in this BBB dysfunction through regulation of barrier-forming tight junction (TJ) proteins.

**Aims:** We hypothesize that inhibition of a specific  $\beta 1$  integrin subtype,  $\alpha 5\beta 1$ , after experimental stroke will stabilize the BBB through the TJ protein claudin-5, and thereby reduce infarct volumes and improve functional recovery.

**Methods:** Transient middle cerebral artery occlusion was performed on 12-week-old mice for 1 hour. Intraperitoneal injection of saline vehicle or the small peptide  $\alpha 5\beta 1$  inhibitor ATN-161 (1mg/kg), which has been successfully employed in cancer clinical trials as an anti-angiogenic therapy, was performed immediately after reperfusion, on post stroke day (PSD) 1, and PSD2 (n=12). Infarct volume was determined by TTC staining of brain sections on PSD3. In additional experiments, a 5-point Neuroscore determined functional behaviour after ATN-161 treatment through PSD14 (n=10). Physiological measurements, including pulse distention, heart rate and body temperature, were obtained before, during and after the initial dose of ATN-161. Immunohistochemical analysis of  $\alpha 5\beta 1$ , claudin-5, NeuN, GFAP, and IgG expression was performed on PSD3 and PSD14.

**Results:** Therapeutic inhibition of  $\alpha 5\beta 1$  significantly reduced infarct volume and improved functional recovery. Additionally, immunohistochemistry stains demonstrated neuroprotection and reduction of BBB permeability after inhibition of  $\alpha 5\beta 1$ .

**Discussion:** Inhibition of  $\alpha 5\beta 1$  with the repurposed small peptide inhibitor ATN-161 produced significant benefits after experimental stroke and could represent a novel stroke therapy worthy of further investigation.

**178 Morphine regulates cellular migration and invasion by modifying the circulating proteolytic profile in mice**

Nan Xie<sup>1</sup>, Samira Khabbazi<sup>1</sup>, Zeyad D. Nassar<sup>1</sup>, Kye Gregory<sup>2</sup>, Tharindu Vithanage<sup>2</sup>, Bela Anand-Apte<sup>3</sup>, Peter J. Cabot<sup>1</sup>, David Sturgess<sup>2</sup>, Paul N. Shaw<sup>1</sup>, Marie-Odile Parat<sup>1</sup>. <sup>1</sup>School of Pharmacy, The University of Queensland, St Lucia, QLD, <sup>2</sup>Mater Research Institute (MRI-UQ), The University of Queensland, Brisbane, QLD, <sup>3</sup>Department of Ophthalmology, Cole Eye Institute, Cleveland Clinic Lerner College of Medicine, Case Western Reserve University<sup>3</sup>, Cleveland, OH, USA

**Introduction:** Opioids have been suggested to modulate cell adhesion and migration in different cancer types, thereby influencing their metastatic potential. We have previously demonstrated that administration of morphine to tumour-bearing mice significantly decreased circulating matrix metalloprotease (MMP)-9 (Afsharimani et al, 2014). In this study, we report that morphine administration to tumour-free mice alters their circulating proteolytic profile.

**Methods:** Serum from morphine (1 or 10 mg/kg every 12 h for 3 days)- or control, saline-treated, mice was collected at different time points and tested *ex vivo* in endothelial, lymphatic endothelial and breast cancer cell migration and reconstituted basement membrane cell invasion assays. Circulating MMP and Tissue Inhibitor of Matrix Protease (TIMP) activities were assessed by zymography and reverse zymography. Quantitative RT-PCR was used to measure MMP-9 and TIMP expression in multiple organs collected at day 3 from these mice.

**Results:** Serum from mice treated with 10 mg/kg morphine for 3 days displayed reduced chemotactic potential for endothelial and breast cancer cells, and elicited lesser breast cancer cell invasion compared to serum from saline-treated mice. This was associated with decreased circulating MMP-9 and increased circulating TIMP-1 and -3/4. This was confirmed by variations of MMP-9 and TIMP expression in several organs after morphine administration. Pharmacological inhibition of MMP-9 nullified the difference of the ability of breast cancer cells to migrate or invade towards serum from saline- or morphine-treated mice, indicating that MMP-9 may play a key role in the effect of morphine on *ex vivo* cell migration and invasion.

**Discussion:** This novel mechanism signals that morphine administration may promote an environment less conducive to tumour growth, invasion and metastasis.

Afsharimani B et al (2014) Clin Exp Metastasis 31:149-58.

**179 Stress induced analgesia is reduced in neuropathic pain states**

Nicholas Atwal and Christopher W Vaughan, Pain Management Research Institute, Kolling Institute for Medical Research, University of Sydney, Sydney, NSW, Australia

**Introduction:** It is well known that acute stress can produce pain relief (stress-induced analgesia) and that this is mediated by a descending analgesic pathway (Butler and Finn, 2009). It is known that this analgesic pathway is altered in chronic neuropathic pain states, but the effect of this on stress-induced analgesia is unknown.

**Aims:** The objective of this study was to determine if stress-induced analgesia is altered in a neuropathic pain state.

**Methods:** Adult male C57BL/6 mice underwent chronic constriction injury (CCI) of the sciatic nerve, or matched sham surgery, and animals were assessed at 8 days post-surgery. Stress was induced using restraining devices for 30 mins. Analgesia was measured using the hot plate and Hargreaves test. The nature of the stress-induced analgesia produced was determined through acute subcutaneous drug injections of various antagonists which included naltrexone (15mg/kg), AM281 (3mg/kg), AM630 (3mg/kg) and RU-486 (50mg/kg).

**Results:** Sham operated mice which were subjected to restraint stress demonstrated longer hot plate and Hargreaves latencies than those which were not restrained ( $P < 0.05$ ). For the hot plate test, naltrexone and RU-486 reduced stress-induced analgesia compared to their respective vehicles ( $P < 0.05$ ). In the Hargreaves test, only the co-administration of naltrexone and AM281 diminished stress-induced analgesia ( $P < 0.05$ ). CCI operated mice displayed significantly lower stress-induced analgesia compared to their sham counterparts ( $P < 0.05$ ).

**Discussion:** Stress-induced analgesia produced in sham animals was largely opioid and cannabinoid receptor mediated. In neuropathic pain states however, stress-induced analgesia was diminished. These findings suggest the descending analgesic pathway is dysfunctional in neuropathic pain states.

Butler RK, Finn DP (2009). Stress-induced analgesia. Prog Neurobiol 88: 184-202.

**180 Phytocannabinoid actions in an animal model of neuropathic pain**

Jessica A Falon<sup>1</sup>, Vanessa A Mitchell<sup>1</sup>, Sherelle L Casey<sup>1</sup>, Jonathon C Arnold<sup>2</sup>, Iain S McGregor<sup>3</sup>, Bryony L Winters<sup>1</sup>, Christopher W Vaughan<sup>1</sup>, <sup>1</sup>Pain Management Research Institute, Kolling Institute for Medical Research, <sup>2,3</sup>Lambert Initiative for Cannabinoid Therapeutics, <sup>2</sup>Discipline of Pharmacology, <sup>3</sup>School of Psychology, University of Sydney, Australia

**Introduction:** Emerging evidence has revealed the potential analgesic efficacy of phytocannabinoids from the plant *Cannabis sativa* in neuropathic pain states. Only its two most prominent constituents have been characterised in regards to pain –  $\Delta^9$ -tetrahydrocannabinol (THC) and cannabidiol (CBD). THC displays high analgesic efficacy in animal neuropathic pain models, though alongside numerous side-effects. By contrast, CBD has lesser analgesic efficacy and lacks cannabinoid-like side-effects (Casey et al, 2017). In light of this, it is possible that one or more of the uncharacterised phytocannabinoids could be effective against neuropathic pain.

**Aims:** To investigate three previously uncharacterised CBD-based phytocannabinoids – cannabidiolic acid (CBDA), cannabidavarin (CBDV) and cannabidavarinic acid (CBDVA) – in a mouse model of neuropathic pain.

**Methods:** Sciatic nerve injury was induced in C57BL/6 mice using the chronic constriction injury (CCI) model and cannabinoids were administered 9 days post-CCI (0.01ml/g s.c. in saline with 10% dimethylsulfoxide, 5% Tween80) under anaesthesia (2% isoflurane in saturated oxygen). Mechanical paw withdrawal threshold and number of pain-like responses to acetone applied to the affected hind paw were used to measure mechanical and cold allodynia. Side effects were also monitored: motor incoordination (rotarod), sedation (dark open field) and catalepsy (bar test).

**Results:** Of the phytocannabinoids tested, CBDV produced the greatest decrease in mechanical and cold allodynia (25 % reduction). CBDV, CBDA and CBDVA produced no significant side-effects. In combination with THC, CBDVA produced a greater reduction in allodynia than THC alone, while producing no significant change in any of the THC side-effects.

**Discussion:** This data indicates that while only minimally effective alone, CBDVA may act synergistically with THC in an animal model of neuropathic pain, and therefore may be a potential candidate for treatment of the condition.

Casey SL, Atwal N, Vaughan CW (2017) Cannabis constituent synergy in a mouse neuropathic pain model. Pain (in press); PMID: 28885457.

**181 Nesfatin-1 suppresses feeding and induces emesis in *Suncus murinus* (House Musk Shrew)**

Sze Wa Chan<sup>1</sup>, Zengbing Lu<sup>1,2</sup>, Takafumi Sakai<sup>3</sup>, Ichiro Sakata<sup>3</sup>, Ge Lin<sup>2</sup>, John A Rudd<sup>2,4</sup>, <sup>1</sup>School of Health Sciences, Caritas Institute of Higher Education, <sup>2</sup>School of Biomedical Sciences and <sup>4</sup>Brain and Mind Institute, The Chinese University of Hong Kong, Hong Kong SAR, China, <sup>3</sup>Graduate School of Science and Engineering, Saitama University, Saitama, Japan

**Introduction:** Nesfatin-1 is an 82-amino acid anorectic peptide derived from nucleobindin2 (NUCB2). NUCB2/nesfatin-1 is expressed in peripheral tissues and also in brain areas involved in the regulation of feeding, emotion and emesis. However, the potential involvement of nesfatin-1 in emesis control is essentially unknown.

**Aims:** The present studies examine the effect of a central administration of nesfatin-1 on feeding, emesis and locomotor activity in *Suncus murinus*.

**Methods:** Animals were anaesthetised with sodium pentobarbitone (40 mg/kg, i.p.) and then stereotaxically implanted with a guide cannula into the lateral ventricle and allowed a 7-days recovery before experimentation. Animals were fasted 12 h prior to administration of drugs. Nesfatin-1 (1-50 pmol, i.c.v.) or saline (5  $\mu$ l, i.c.v.) was administered to conscious fasted animals. Emesis and spontaneous behaviour were measured for 6 h, while food and water consumption was measured hourly for 6 h and at 24 h post-administration.

**Results:** Compared to saline-treated animals, nesfatin-1 (5 pmol, i.c.v.) suppressed the amount of food eaten at 4-, 5- and 6-h by 30.9%, 32.9%, and 29.4%, respectively ( $P < 0.01$ ; cumulative measurements), but it failed to affect the latency to eat ( $P > 0.05$ ). Nesfatin-1 at 1 pmol, i.c.v. suppressed cumulative water intake assessed at 5-h ( $P < 0.05$ ); higher doses (5-50 pmol) had no effect. No statistically significant differences in the 24-h cumulative food and water intake between treatment groups were found. Additionally, nesfatin-1 at 5 pmol i.c.v. induced emesis in 5 out of 6 animals with  $7.5 \pm 4.4$  retches + vomits following a median latency of 39.7 min ( $P < 0.05$ ). Nesfatin-1 had no effect on the locomotor activity.

**Discussion:** To the best of our knowledge, nesfatin-1 is the most potent peptide to induce emesis and inhibit feeding in *S. murinus*. The studies were fully supported by a grant from the Research Grants Council of the Hong Kong SAR, China (Project no. UGC/FDS11/M02/16).

**200 Innovations in clinical pharmacology education**

Clare Guilding<sup>1,2</sup>, <sup>1</sup>Faculty of Medical Sciences, Newcastle University, Newcastle Upon Tyne, UK, <sup>2</sup>Newcastle University Medicine Malaysia, Johor, Malaysia

Education in clinical pharmacology and therapeutics (CPT) is fundamental for the successful practice of medicine, with prescribing an essential skill for most doctors. Yet medical graduates feel underprepared for prescribing in the work place. This is substantiated by high medication error rates in the National Health Service, which combined with the recent introduction of the Prescribing Safety Assessment for UK medical students has sharpened focus on the undergraduate teaching of CPT and prescribing<sup>1</sup>.

We undertook a wholesale review of the CPT curriculum within the MBBS degree programme at Newcastle University, and working with the British Pharmacological Society's core curriculum<sup>1</sup> designed a 'Clinical Pharmacology, Therapeutics and Prescribing' (CPTP) strand which now run throughout our 5 year programme. This strand introduces prescribing competencies into the early years of the course, and includes more experiential learning to provide students with an experience which more closely mirrors the clinical workplace. A range of educational tools have been employed including team based learning, case based learning, interprofessional education and high-fidelity simulation using the sophisticated virtual patient SimMan.

SimMan simulations of medical emergencies (e.g. acute asthma attack, sepsis) have been delivered both in the lecture theatre, and as a team based learning exercise in an interprofessional education conference for pharmacy and medical students. At a series of key clinical points throughout each scenario the students are asked to vote on the most appropriate course of action (e.g. which drug should be administered). The option with the most votes is applied to SimMan and the students then observe the physiological effects this has in real time.

Evaluations of the CPTP strand, simulations and interprofessional education activities have been extremely positive. Students reported that the simulation sessions contextualised the importance of basic pharmacology principles for clinical practice while the interprofessional education sessions allowed them to develop their prescribing, problem-solving, team-working and critical evaluation skills.

1. Ross and Maxwell, 2012. Br J Clin Pharmacol. 74(4): 644–661.

**201 Increasing polypharmacy in aged care facilities: trends, problems and solutions**

Natali Jokanovic, Centre for Medicine Use and Safety, Faculty of Pharmacy and Pharmaceutical Sciences, Monash University, Melbourne, VIC, Australia

Polypharmacy is highly prevalent and increasing in residential aged care facilities with up to 74% of resident taking nine or more medications. The burden and harms associated with polypharmacy are well-known and have resulted in calls for a national strategy to reduce unnecessary or harm medication use. Medications contributing to polypharmacy have recently been highlighted in an Australian cross-sectional study of 27 facilities. These included beta-blockers, antithrombotics, statins, antidepressants and proton-pump inhibitors. Wide variability in the prescribing of these medications was also found across the facilities. A number of challenges and potential solutions have been identified to managing polypharmacy. Interventions currently underway to manage polypharmacy in residential aged care have included initiatives to improve the de-prescribing of unnecessary or inappropriate medications and improving existing medication advisory committees within aged care facilities.

**202 How is Canada addressing the increasing burden of polypharmacy?**

Justin Turner<sup>1</sup> and Cara Tannenbaum<sup>2,3</sup>, <sup>1</sup>Faculté de pharmacie, Université d Montréal, Québec, Canada, <sup>2</sup>Faculté de pharmacie, <sup>3</sup>Faculté de Médecine Université d Montréal, Québec, Canada

**Introduction:** Neither sedative-hypnotics or chronic use of proton pump inhibitors (PPIs) are recommend in older adults, yet they are commonly prescribed across Canada. Prescribers’ skills and capacity for successfully navigating conversations about deprescribing these medications remains unknown.

**Aim:** To identify conversation stumbling blocks that impede successful deprescribing conversations between prescribers and older adults about discontinuing sedative-hypnotics or PPIs.

**Methods:** Family physicians (n=12) and a nurse practitioner (n=1) from Family Medicine Teaching Units across greater Montréal, and patients aged ≥65 years who were prescribed sedative-hypnotics (n=7) or PPIs (n=15) were enrolled. Encounters involving conversations re-evaluating the use of sedative-hypnotics or PPIs were audiotaped. A qualitative thematic analysis was conducted. Emergent themes were coded, and areas for improvement identified.

**Results:** Areas for prescriber improvement include: difficulty clarifying the indication for PPIs; ambivalence towards and difficulty determining the balance of benefit and risk for both drug classes; greater concern about the harms from withdrawal than the harms of continued prescribing, especially for PPIs; fear and reluctance to deprescribe due to the risks of symptom return; lack of reference to tapering schedules; inadequate discussion of alternative drug and non-drug therapies including melatonin or cognitive behavioural therapy for insomnia; deferral to patient preference to continue sedative-hypnotics; discomfort with assertive deprescribing and lack of affirmation of the necessity for deprescribing

**Discussion:** Education, tools and coaching are required to increase prescribers’ skills and confidence for successfully implementing a patient-centred deprescribing plan for sedative-hypnotics and chronic use of PPIs.

**203 Integrating prescribing and dispensing data across primary care, hospitals and aged care: The MedView Project**

David Freemantle, General Manger eHealth, Fred IT Group, Abbotsford, Victoria

Introduction. The Convergence of Health care and data has long been an identified opportunity to improve health outcomes, drive system efficiency and reduce the costs to the state and federal funders.

For the last 9 years, Fred IT Group has been operating the eRx Script Exchange prescription exchange service across Australia and the benefits of the data generated are starting to come to life. Whether it be data for Real Time Prescription Monitoring (RTPM) to help address prescription drug overdoses, providing better care in an Emergency Department due to improved quality and completeness of medications information, better managing a patient’s transition between different parts of the health sector, or multiple other use cases, effective collection and use of medications data improves outcomes and saves lives.

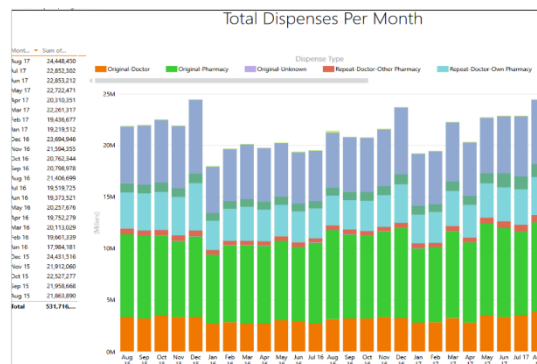

Aged Care is an area requiring fundamental change in the way patient data is managed and maintained, particularly as patients transition from the community setting into aged care and between their facility and hospital. The sharing of comprehensive medications information is vital in enabling these improvements.

RTPM is another area of significant focus for Advocacy Groups, IT Companies, State and Federal Governments and Coroner’s Courts across the nation. With three Australians dying every day from prescription drug misuse<sup>1</sup>, the problem is widespread, growing and widely acknowledged.

Fred IT Group’s MedView service consolidates data from multiple sources (including eRx Script Exchange) and presents that data to health practitioners and patients at the various points of care. Such initiatives have the potential to save lives, reduce load on the health system and improve clinical outcomes for patients.

<sup>1</sup> Penington Institute: Australia’s Annual Overdose Report 2016

**204 Application of a structured approach to simplify medication regimens in residential aged care**

Janet K Sluggett<sup>1,2</sup>, <sup>1</sup>Centre for Medicine Use and Safety, Faculty of Pharmacy and Pharmaceutical Sciences, Monash University, Parkville, VIC, Australia, <sup>2</sup>National Health and Medical Research Council (NHMRC) Cognitive Decline Partnership Centre, Hornsby Ku-ring-gai Hospital, Hornsby, NSW, Australia

The high prevalence of polypharmacy, together with a multiplicity of medication administration times, formulations and special dosing instructions, means that complex medication regimens are common in residential aged care facilities (RACFs). Strategies to reduce unnecessary medication complexity in RACFs are likely to be valued by residents and aged care providers because complex regimens can be burdensome for residents and may present opportunity costs in terms of nursing time. In some cases, it may be possible to reduce unnecessary medication complexity by administering different medications at the same time of day and/or prescribing slow release or combination formulations. Researchers from the Centre for Medicine Use and Safety at Monash University are working closely with Helping Hand Aged Care and other members of the NHMRC Cognitive Decline Partnership Centre to undertake the 'Simplification of Medications Prescribed to Long Term care Residents' (SIMPLER) study. SIMPLER is a non-blinded, matched-pair, cluster randomised controlled trial of a single multidisciplinary intervention to simplify medication regimens in RACFs. Trained study nurses have recruited more than 240 permanent residents from eight South Australian RACFs to participate in the SIMPLER study. An experienced pharmacist is using a validated, five-item implicit tool to identify opportunities to reduce the number of medication administration times for residents in the intervention arm, and discuss recommendations with relevant stakeholders. Participants will be followed for up to 36 months after study entry. The primary outcome of the SIMPLER study is the total number of medication administration times per day at four months post study entry. Secondary outcomes include the total number of medication administration times at 8 and 12 months after study entry, time spent administering medications, medication incidents, resident satisfaction and quality of life, hospitalisations, falls and mortality. Early results indicate that opportunities for medication regimen simplification may be present for up to two thirds of residents who have received the intervention. SIMPLER will quantify the impact of medication regimen simplification on a range of outcomes that are important for residents and aged care providers.

#### 205 Adipokines, cardiovascular function and brain inflammation

Emilio Badoer, School of Health and Biomedical Sciences, RMIT University, Melbourne Victoria Australia

**Introduction:** Leptin and Resistin are adipokines produced in adipose tissue. Resistin acts centrally to increase renal sympathetic nerve activity (RSNA). This is similar to leptin, suggesting activation of some common brain pathways. High-fat feeding can reduce the number of activated neurons and effects on dietary intake observed following the central administration of leptin. In contrast, the sympatho-excitatory effects of leptin are retained. The effects on resistin were unknown.

**Aims:** We investigated whether the sympatho-excitatory actions of resistin and the pathways activated were influenced by a high fat diet. Further, since resistin and leptin combined can induce a greater sympatho-excitatory response than each alone in rats fed a normal chow diet, we investigated whether a high fat diet (22%) could influence this centrally mediated interaction.

**Methods:** MAP, HR and RSNA were recorded before and for 3 hours after intracerebroventricular saline (control) leptin (7 µg), resistin (7 µg) and leptin and resistin combined. The distribution of neurons in the brain that were activated by centrally administered resistin, or leptin alone, and, in combination, in rats fed a high fat (HFD) compared to a normal chow diet (ND) were compared. Immunohistochemistry for the protein, Fos, was used as a marker of activated neurons.

**Results:** With HFD, Leptin alone and resistin alone significantly increased RSNA (71±16%, 62±4% respectively). When leptin and resistin were combined there was a significantly greater increase in RSNA (195±41%) compared to either hormone alone. MAP and HR responses were not significantly different between hormones. When the responses in high fat fed rats were compared to normal chow fed rats, there were no significant differences in the maximum RSNA responses. The number of activated neurons in the paraventricular and arcuate nuclei were significantly increased following resistin or leptin, either alone or combined in rats fed a normal diet but this was not the case with HFD.

**Discussion:** The findings indicate that sympatho-excitatory effects of resistin on RSNA are not altered by high fat feeding. Our results suggest that diets rich in fat do not induce resistance to the increase in RSNA induced by resistin alone or in combination with leptin. This could have implications in understanding the mediators of the abnormally elevated RSNA observed in conditions of overweight / obesity.

**206 Mineralocorticoid and estrogen receptors: Novel therapeutic targets in cardiovascular disease and stroke?**

Quynh Nhu Dinh<sup>1,2</sup>, Antony Vinh<sup>1,2</sup>, Brad R.S. Broughton<sup>2</sup>, Sophocles Chrissobolis<sup>3</sup>, Grant R. Drummond<sup>1,2</sup> and Christopher G. Sobey<sup>1,2</sup>, <sup>1</sup>Department of Physiology, Anatomy and Microbiology, La Trobe University, Bundoora, VIC, Australia, <sup>2</sup>Department of Pharmacology, Monash University, Clayton, VIC, Australia, <sup>3</sup>Department of Pharmaceutical and Biomedical Sciences, Raabe College of Pharmacy, Ohio Northern University, Ohio, USA

**Introduction:** Some effects of aldosterone may be modulated by the G protein-coupled estrogen receptor 1 (GPER) via an interaction with the mineralocorticoid receptor. The GPER agonist, G-1, can exert T cell-mediated anti-inflammatory actions, acutely lower blood pressure (BP), and reduce post-stroke infarct injury.

**Aims and Methods:** Here we tested the effects of G-1 (0.03 mg/kg/d) and G-15 (GPER antagonist; 0.3 mg/kg/d) on BP over 14 d in two models of hypertension: 1) aldosterone/salt (0.72 mg/kg/d + 0.9 % NaCl for drinking) and 2) angiotensin II (0.7 mg/kg/d); and assessed sex differences and also the role of lymphocytes in those effects.

**Results:** In male C57Bl6 mice, the aldosterone/salt-induced increase in BP (~25 mmHg) was attenuated by ~50 % with co-administration of G-1. G-15 did not alter aldosterone/salt-induced hypertension in male C57Bl6 but prevented the anti-hypertensive effect of G-1. Moreover, whereas aldosterone/salt alone had no effect on BP in female C57Bl6 mice for >7 d, co-administration of G-15 with aldosterone/salt resulted in a prompt increase of ~20 mmHg by d 7. There was virtually no effect of aldosterone/salt on BP in either male or female RAG1-deficient mice. Neither G-1 nor G-15 had any effect on angiotensin II-induced hypertension in male C57Bl6 mice. T cells, B cells, macrophages and neutrophils in spleen and kidneys were found to have high expression of GPER.

**Discussion:** Thus, aldosterone/salt-induced hypertension appears to be strictly lymphocyte-dependent and is markedly suppressed in females due to GPER activity. Activation of GPER on T and/or B cells by endogenous estrogen or by administration of G-1 selectively reduces hypertension caused by aldosterone/salt.

**207 The paradox of Z-drugs in motor recovery after stroke**

Mary Chebib<sup>1</sup>, Petra van Nieuwenhuijzen<sup>1</sup>, Vanesse Chan<sup>1</sup>, Philip Ahring<sup>1</sup>, Andrew N. Clarkson<sup>1,2</sup>, <sup>1</sup>Faculty of Pharmacy, The University of Sydney, Sydney, NSW, Australia, <sup>2</sup>Department of Anatomy, Brain Health Research Centre and Brain Research New Zealand, University of Otago, Dunedin, New Zealand

Zolpidem (Stilnox) is an intriguing molecule. Paradoxically, this “sleeping pill” is reported to reverse speech, cognitive and motor deficits in some Parkinson’s disease, progressive supranuclear palsy, severe brain injury and stroke patients. Generally, zolpidem mediates its hypnotic effects via cell surface proteins, called  $\gamma$ -aminobutyric acid type A receptors (GABAARs) and specifically the ubiquitous synaptic  $\alpha 1\beta\gamma 2$  subtype. Here zolpidem binds to the benzodiazepine ( $\alpha 1-\gamma 2$ ) site and acts similarly to benzodiazepines such as diazepam. However, the “awakening” effects of zolpidem in patients are not observed with benzodiazepines (e.g. diazepam and alprazolam) and are thus, unrelated to actions mediated from the classical benzodiazepine site. In this presentation, I will present the effects of zolpidem and other agents in mice stroked using a photothrombotic approach with drug intervention starting at various time points before assessing motor function, and discuss targets that could contribute to these effects in an attempt to identify the mechanism for this unusual effect.

**208 Targeting oxidant-dependent pathways to treat cognitive dysfunction in chronic obstructive pulmonary disease**

Ross Vlahos, School of Health & Biomedical Sciences, RMIT University, Bundoora, VIC, Australia

Chronic obstructive pulmonary disease (COPD) is a major incurable global health burden, affects 210 million people worldwide and is currently the 3<sup>rd</sup> largest cause of death in the world<sup>1</sup>. COPD costs the Australian community over \$8.8 billion per year and causes substantial morbidity and mortality<sup>2</sup>. Importantly, much of the disease burden and health care utilisation in COPD is associated with the management of its comorbidities and viral and bacterial-induced acute exacerbations of COPD (AECOPD)<sup>1</sup>. Because comorbidities have a major impact on the severity and prognosis of COPD, the recent American Thoracic Society/European Respiratory Society Research Statement on COPD launched an urgent call for studies to elucidate the pathobiological mechanisms linking COPD to its comorbidities<sup>3</sup>. Recent clinical studies have shown that cognitive dysfunction is present in up to 60% of COPD patients, with impairment in memory, attention and executive function<sup>4</sup>. In addition, comorbid cognitive dysfunction impacts on important outcomes such as quality of life, hospitalisation and survival<sup>4</sup>. The high prevalence of cognitive dysfunction in COPD may also help explain the insufficient adherence to therapeutic plans and strategies, thus exacerbating and increasing the social costs in COPD subjects. The mechanisms underlying brain pathology and cognitive impairment in COPD are largely unknown. We propose that the increased oxidative stress and inflammation observed in COPD lungs 'spill over' into the systemic circulation causing damage to other organs (e.g. brain) manifesting in comorbidities of COPD such as cognitive dysfunction. Thus, an understanding of the mechanisms underlying neuroinflammation and cognitive dysfunction will reveal new targets, including oxidative stress, to treat cognitive dysfunction in COPD.

1. Vogelmeier CF et al (2017) *Am J Respir Crit Care Med* 195:557-82.
2. Access Economics Report for Australian Lung Foundation (2008) 1-70.
3. Celli BR et al (2015) *Am J Respir Crit Care Med* 191(7):e4-e27.
4. Dodd JW. (2015) *Alzheimers Res Ther* 7(1):32.

**209 Decoding spinal cord circuits to find novel targets for chronic pain**

Wendy L Imlach, Monash Biomedicine Discovery Institute and Department of Physiology, Monash University, Melbourne, VIC, Australia

**Introduction:** The development of neuropathic pain involves persistent changes in signalling within nociceptive pathways. Reduced inhibitory signalling in the spinal cord following nerve-injury has been used to explain sensory signs of neuropathic pain but specific circuits that lose inhibitory input have not been identified. Understanding the molecular, cellular, and physiological basis of changes in circuit activity in disease is central to identifying novel drug targets and the development of more effective therapeutics.

**Aims:** In this talk I will discuss our recent identification and characterization of a nociceptive circuit that becomes more excitable in a rat model of chronic pain and our approaches to pharmacologically target the activity of affected neurons.

**Methods:** Studies of spinal cord signalling and circuit activity were performed using patch-clamp electrophysiology, optogenetic activation, calcium imaging and immunohistochemistry.

**Results:** We found that a specific population of spinal cord interneurons, radial neurons, lose glycinergic inhibitory input in a rat partial sciatic nerve ligation (PNL) model of neuropathic pain. These neurons also undergo a change in postsynaptic receptors, which may contribute to their change in activity. This study characterizes these interneurons and their inputs and outputs within the nociceptive circuit.

**Discussion:** This study has important implications as it identifies a glycinergic synaptic connection in a specific population of dorsal horn neurons where loss of inhibitory signalling may contribute to signs of neuropathic pain. This raises the challenge of identifying selective targets within this sub-circuitry to optimize therapeutics for minimal side effects.

**210 Nav1.7 as a target for pain treatment: Therapeutic challenges and opportunities**

Sulayman D. Dib-Hajj, PhD. Dept Neurology, Yale School of Medicine, West Haven, CT, USA, Center for Restoration of Nervous System Function, Veterans administration Medical Center, West Haven, CT, USA

**Background:** A monogenic link of *SCN9A*, the gene that encodes sodium channel Nav1.7, and pain disorders in humans has provided compelling evidence that this channel is a major contributor to the pathophysiology of pain. Dominant and fully penetrant gain-of-function mutations in Nav1.7 have been found in two severe pain syndromes, inherited erythromelalgia (IEM) and paroxysmal extreme pain disorder (PEPD), while recessive loss-of-function mutations have been found in patients with congenital insensitivity to pain (CIP). CIP patients do not manifest cardiac, motor or cognitive deficits. Variants in Nav1.7 in patients with the more common painful disorder small fiber neuropathy have been identified and have shown in functional assays that they confer gain-of-function attributes on the channel, but are less penetrant and generally manifest symptoms at middle age. Electrophysiological characterization of mutations in Nav1.7 has now elucidated the molecular basis for altered excitability of DRG neurons that express these mutant channels, establishing a mechanistic link to human pain conditions. These findings validate the Nav1.7 peripheral sodium channels as a target for development of new pain therapeutics.

**Discussion:** A new class of sulfonamide-based isoform-selective blockers of Nav1.7 has been developed and a prototype was tested in a clinical trial on a small number of patients with IEM. Other molecules of the same class are under development. Another new sodium channel blocker with a reported Nav1.7 selectivity was tested in a cohort with trigeminal neuralgia. Both trials reported promising secondary endpoints. Approaches including atomic structural modeling and pharmacological testing in vitro have also proven useful to predict the response of neurons expressing specific Nav1.7 mutant channels to existing drugs, and the successful implementation of this strategy in a personalized clinical application was recently reported.

**211 GPCRs and ion channels: The cause of and solution to chronic visceral pain?**

Stuart M. Brierley<sup>1,2</sup>, <sup>1</sup>Human Physiology, Centre for Neuroscience, Flinders University, Adelaide, SA, <sup>2</sup>South Australian Health and Medical Research Institute (SAHMRI), Adelaide, SA

There is increasing pre-clinical and clinical evidence that infection and inflammation are key risk factors for the development of some subtypes of Irritable Bowel Syndrome (IBS) <sup>1</sup>. Extrinsic sensory afferents are at the start of the pain-processing pathway and are therefore key targets for treating chronic visceral pain (CVP) associated with IBS.

This seminar will highlight the fundamental properties of extrinsic sensory afferent nerves innervating the gut and highlight how inflammation can trigger long-term neuroplasticity <sup>1</sup>. In particular, it will focus on the latest evidence for how specialized cells within the gut wall allow the gut to ‘talk’ to the brain <sup>2</sup>. It will also highlight the key ion channels <sup>3</sup> which ultimately underlie aberrant neuronal function and gastrointestinal symptoms. Finally, this talk will highlight recent evidence that has identified several novel receptors that hold promise for future selected pharmacotherapy for inhibiting colonic afferents in the treatment of CVP in IBS.

<sup>1</sup> Brierley SM and Linden DR (2014). Nature Reviews Gastroenterology and Hepatology. 2014 Oct;11(10):611-27.

<sup>2</sup> Bellono N et al., (2017). Cell. 2017. 170, Issue 1, p185–198.e16

<sup>3</sup> Osteen JD et al., (2016). Nature. 2016 Jun 6;534(7608):494-9.

**212 Mechanosensors and pain**

Kate Poole, EMBL Australia Node for Single Molecule Science, School of Medical Sciences, UNSW Sydney, NSW, Australia

**Introduction:** The skin is innervated by specialised mechanoreceptors that allow the perception of gentle touch. The initial transduction event that mediates this sense of touch is the conversion of mechanical movements into an electrical signal via activation of mechanosensitive ion channels. The sensitivity of these ion channels can be regulated by the membrane scaffolding protein STOML3. In some pathophysiological pain states, fine mechanical stimuli are falsely perceived as noxious. However, touch-evoked pain responses (that indicate such mechanical hypersensitivity) are inhibited in *Stoml3*<sup>-/-</sup> mice.

**Aims:** The aim of this study was to determine whether we could identify STOML3-targeting compounds that reverse mechanical hypersensitivity.

**Methods:** Elastomeric pillar arrays were used to characterise the role of STOML3 in tuning mechanosensitivity and a small-molecule screen was performed to identify compounds that disrupted STOML3 oligomerisation.

**Results:** We have identified compounds that disrupt STOML3 oligomerisation. The application of these compounds to cells changes STOML3-defined domains and inhibits sensitisation of mechanically gated ion channels by STOML3. These compounds were also found to reversibly attenuate touch perception and block mechanical hypersensitivity in some neuropathic pain states.

**Discussion:** Applying compounds to the skin that locally modulate mechanotransduction may represent a novel treatment for the mechanical hypersensitivity that occurs post nerve injury.

Poole K et al (2014) Nat Commun 5:3520

Wetzel C et al (2017) Nat Neurosci 20:209-218

**213 CESTEM-1 clinical trials: using dynamin inhibitors to reverse resistance to monoclonal antibody therapy**

Jermaine Coward<sup>1,6</sup>, Katharine Cuff<sup>2</sup>, Godwins Echejoh<sup>3</sup>, Hui Yi Chew<sup>3</sup>, Shannon Joseph<sup>3</sup>, Blerida Belushi<sup>3</sup>, Brigid King<sup>3</sup>, Sally Yukiko<sup>3</sup>, Priscilla De Olivia<sup>3</sup>, Annabelle Genko<sup>3</sup>, Alexander Grainger<sup>3</sup>, Satomi Okano<sup>3</sup>, Ian H. Frazer<sup>3</sup>, James Wells<sup>3</sup>, Matthew Foote<sup>4</sup>, Jennifer Martin<sup>5</sup>, Ben Panizza<sup>2,6</sup> and Euan Walpole<sup>1,2</sup>, Fiona Simpson<sup>3,6</sup>, <sup>1</sup>Cancer Services, Department of Oncology, Princess Alexandra Hospital, Woolloongabba, Australia, <sup>2</sup>Faculty of Medicine, University of Queensland, Australia, <sup>3</sup>University of Queensland Diamantina Institute, Faculty of Medicine, University of Queensland at The Translational Research Institute, Woolloongabba, Queensland, Australia, <sup>4</sup>Department of Radiation Oncology, Princess Alexandra Hospital, Woolloongabba, Australia, <sup>5</sup>School of Medicine and Public Health, University of Newcastle, Newcastle, New South Wales, Australia, <sup>6</sup>Queensland Head and Neck Cancer Centre and The Department of Otolaryngology, Princess Alexandra Hospital, Queensland, Australia

The monoclonal antibody (mAb) cetuximab is an important component of cancer therapy for the treatment of squamous cell carcinoma (SCC). Cetuximab targets the epidermal growth factor receptor (EGFR) but patient responses are unpredictable and the biological determinants of antibody therapy sensitivity remain unknown. We hypothesised that the trafficking status of the EGFR may impact the efficacy of the monoclonal antibody treatments directed at this receptor. Analysis of pre-treatment patient SCC tumours showed EGFR trafficking defects which correlated to positive patient outcome after anti-EGFR mAb therapy. By modulating EGFR trafficking in vitro using dynamin inhibitors which blocked the EGFR on the plasma membrane we were able to enhance anti-EGFR mAb (cetuximab)-induced SCC tumour cell death by antibody dependent cellular cytotoxicity (ADCC) in both cetuximab-sensitive and insensitive SCC cells. In contrast, blocking endocytosis with clathrin inhibitors did not promote ADCC. While both classes of endocytosis inhibitor increased cell surface levels of EGFR, only the dynamin inhibitors induced their cell surface clustering, which may directly influence immune cell activation. Therefore induction of EGFR clustering may promote improved ADCC response in patients, suggesting a new model for targeted combination therapy of cetuximab with dynamin inhibitors. Significantly, we showed in vitro and in mouse models that the commonly used anti-nausea drug, prochlorperazine, inhibited dynamin, and in combination with cetuximab increased ADCC and cleared tumour burden, respectively. This data supported a phase 1 proof of mechanism trial where we showed in patient tumour biopsies that after prochlorperazine infusion, EGF ligand uptake was blocked at the cell plasma membrane. Together this data has informed the CESTEM study - Open-label Phase I study investigating the safety and efficacy of Cetuximab and prochlorperazine (STEMetil) combination therapy in patients with metastatic Head and Neck Squamous Cell Carcinoma, Triple Negative Breast Cancer and Adenoid Cystic Carcinoma. This work is a translation of our laboratory findings to the clinic and is being performed in collaboration with PA Hospital. This trial has the potential to change clinical practice for numerous mAbs used for cancer treatment and improve patient outcomes.

### 214 i-bodies against the chemokine receptor CXCR4 with novel pharmacology

Michael Foley<sup>1,2</sup>, Kate Griffiths<sup>1,2</sup>, William Darby<sup>1,2</sup>, Chris Hosking<sup>1,2</sup>, Xilun Wang<sup>1</sup>, <sup>1</sup>Adalta Limited, 15/2 Park Drive Bundoora, VIC Australia, <sup>2</sup>Department of Biochemistry and Genetics, La Trobe Institute for Molecular Science, La Trobe University, Bundoora, Melbourne, VIC Australia

i-bodies are small, stable, human scaffolds engineered from information gained from the shark single domain antibodies. The presence of a long CDR3 enables better access to complex proteins such as GPCRs and ion channels. We have screened this phage displayed i-body library on GPCRs and ion channels expressed in different formats. We have obtained a panel of high affinity single domain antibodies specific for the chemokine receptor CXCR4. CXCR4 is known to be upregulated in a number of cancers and recently has been implicated as a central player and a therapeutic target in fibrosis. Although all i-bodies bind with high affinity each of the i-bodies have different functional profiles with respect to modulation of cAMP, calcium efflux, inhibition of  $\beta$ -arrestin signaling and subsequently have different *in vitro* and *in vivo* activities. When the lead i-body Ad-114 was injected intraperitoneally they were found to completely block SDF-1-induced leukocyte recruitment in an air pouch model of inflammation in mice. Importantly, unlike most other CXCR4 antagonists, they did not mobilize stem cells from the bone marrow. Thus these i-bodies would be ideal for long-term anti-fibrosis therapy. Indeed we have shown that the i-bodies are able to block the recruitment of fibrocytes into the lungs of mice with bleomycin induced pulmonary fibrosis and that the anti CXCR4 i-bodies have anti-inflammatory and anti-fibrotic effects in several different animal models. Moreover we suggest that the i-body technology provides a unique resource for obtaining a toolbox of human antibody single domains to currently intractable membrane proteins.

### 215 Antibody-polymer-drug conjugates for biomedical applications

Charlotte C Williams, Fei Huang, Xiaojuan Hao, Judith Scoble, Luisa Pontes-Braz, Tim Adams, Andrew Riches, Wioleta Kowalczyk, Ezio Rizzardo, Graeme Moad, John Chiefari, Manufacturing, CSIRO<sup>1</sup>, Melbourne, VIC, Australia

**Introduction:** We have developed a platform drug-delivery technology based on the versatility of the Reversible Addition-Fragmentation chain Transfer (RAFT) process to help deliver polymer-based materials for biomedical applications.

**Aims:** The approach is based on developing RAFT technology to address key clinical and technical challenges for the use of polymeric materials in therapeutic delivery systems.

**Methods:** We report therapeutic antibody-polymer-drug conjugates, where the polymer acts as a carrier for both a small molecule cytotoxic drug as well as a therapeutic protein, such as an antibody. In order to understand the influence of polymer structure, composition and size on biological performance, we report the results of two, first in class, ADME studies. These studies assess the pharmacokinetics of a range of homo-polymer and co-polymer antibody-fragment conjugates, in animal models.

**Results:** All of the antibody fragment-polymer conjugates investigated had increased elimination phase half-lives over the PEG control, and although differences were observed within the circulating half-life between the conjugates (arising from the different polymer compositions), the excretion volume is fairly consistent.

**Discussion:** This result confirms that this range of RAFT polymers are a suitable platform for delivery of proteins and targeted delivery of small molecule drugs. We have conjugated an ADME optimised, complex, high molecular weight, terpolymer containing a number of cytotoxic drugs, attached via cleavable linkers, to antibody fragments and the results of a drug-loaded polymer-antibody fragment conjugate (Figure) *in vivo* efficacy study will be reported.

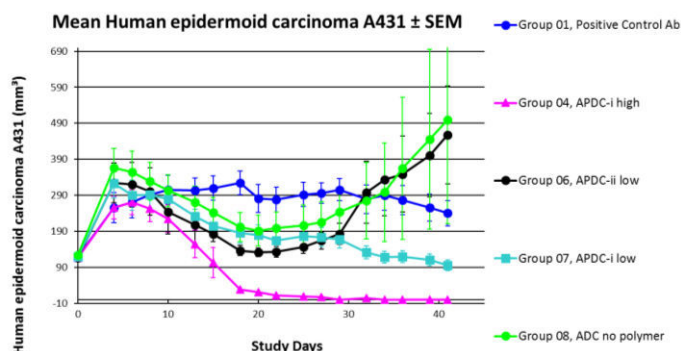

**216 Downsizing disulfide-rich bioactive peptides**

Richard J Clark<sup>1</sup>, School of Biomedical Sciences, The University of Queensland, Brisbane, QLD, Australia

Disulfide-rich peptides typically exhibit high potency and selectivity for their molecular targets and therefore represent promising drug leads. The disulfide bonds within these peptides help to define the three-dimensional shape of the peptide, which is often crucial for function, and also provide stability against denaturation and proteases. However, the presence of multiple disulfide bonds in a peptide can often make the synthesis challenging as multiple disulfide regioisomers can be formed. In this talk I will present our work on elucidating the structure/function activity of disulfide-rich peptides, the challenges we have faced in correctly folding these peptides and how these studies have allowed us to minimize some peptides to key bioactive epitopes that are much simpler and efficient to produce but still retain the full activity of the parent peptide.

**217 Gene delivery targeting cardiac O-GlcNAc modification limits diabetic cardiomyopathy**

Darnel Prakoso<sup>1,2</sup>, Helen Kiriazis<sup>1</sup>, Mitchel Tate<sup>1</sup>, Hongwei Qian<sup>1</sup>, Minh Deo<sup>1</sup>, Laura J Parry<sup>2</sup>, Paul Gregorevic<sup>1</sup>, Xiao-Jun Du<sup>1</sup>, John C Chatham<sup>4</sup>, Miles J De Blasio<sup>1,2</sup>, Rebecca H Ritchie<sup>1,3</sup>, <sup>1</sup>Baker Heart and Diabetes Institute, Melbourne, VIC, AU, <sup>2</sup>School of BioSciences and <sup>3</sup>Dept of Pharmacology and Therapeutics, University of Melbourne, Melbourne, VIC, AU, <sup>4</sup>Dept of Pathology, University of Alabama at Birmingham, Birmingham, AL, USA

**Introduction:** O-GlcNAc post-translational modification has been implicated in the development and progression of diabetic cardiomyopathy. Two enzymes regulate this modification; O-GlcNAc transferase (OGT) facilitates addition of the O-GlcNAc sugar moiety to ser/thr residues, and O-GlcNAcase (OGA) which facilitates its removal.

**Aims:** To study the impact of cardiac-targeted OGA and OGT adeno-associated viral (AAV) gene delivery in the setting of diabetic cardiomyopathy *in vivo*.

**Methods:** Diabetes was induced in 6wk-old male mice using streptozotocin (55mg/kg/day i.p./day, 5 days). After 8wks of diabetes, LV diastolic dysfunction was confirmed by echocardiography. A single i.v. injection of rAAV6-OGA, rAAV6-OGT or null (2x10<sup>11</sup> vg) was administered, and mice were followed for a further 8wks.

**Results:** As shown in the table, OGA gene delivery attenuated diabetes-induced LV diastolic and systolic dysfunction, and limits increases in hypertrophic and pro-fibrotic gene expression. In contrast, OGT gene delivery in nondiabetic mice tended to replicate characteristics of diabetic cardiomyopathy.

**Conclusion:** Targeting LV O-GlcNAc modification may be a potential therapeutic target in the setting of diabetic cardiomyopathy.

Results: (mean±SEM)	Sham			Diabetes		
	Null	OGT	OGA	Null	OGT	OGA
Body Weight (g)	34.8±0.9	35.4±1.0	33.6±0.7	31.2±0.7	31.1±0.7	30.1±0.6
Blood Glucose (mM)	10.1±0.5	9.6±0.4	9.7±0.5	32.0±0.7*	30.8±1.2*	29.4±1.0*
HbA1c (%)	3.2±0.1	3.7±0.2	3.5±0.2	9.6±0.6*	9.0±0.5*	8.7±0.5*
E/A Ratio	2.5±0.2	2.0±0.1	2.5±0.2	1.6±0.1*	1.6±0.1*	2.1±0.2 <sup>†</sup>
IVRT (ms)	14.6±0.9	17.4±1.0	16.0±0.8	21.3±1.2*	19.6±0.7*	16.1±0.6 <sup>†</sup>
FS (%)	39±0.7	33±0.7*	39±1.0	35±0.4*	36±0.7	41.0±1.6 <sup>#</sup>
LV β-MHC (fold)	1.0±0.1	1.8±0.5	0.9±0.1	3.2±0.6*	3.6±0.6*	2.4±0.3
LV CTGF (fold)	1.0±0.1	1.5±0.2	0.9±0.1	2.3±0.3*	2.0±0.3*	1.5±0.1 <sup>†</sup>

\*P<0.05 vs sham-null; <sup>†</sup>P<0.05 vs diabetic-null; <sup>#</sup>P<0.05 vs diabetic-OGT; HbA1c: glycosylated haemoglobin; IVRT: isovolumic relaxation time; FS: fractional shortening; CTGF: connective tissue growth factor; β-MHC: β-myosin heavy chain. n=10-15/group.

**218 The Safety of Metformin in Haemodiafiltration**

Felicity C Smith<sup>1,2</sup>, Timothy J Furlong<sup>3</sup>, Jerry R Greenfield<sup>4</sup>, Sophie L Stocker<sup>1,5</sup>, Jane E Carland<sup>1,5</sup>, Garry G Graham<sup>1,2</sup>, Kenneth M Williams<sup>1,2</sup>, Richard O Day<sup>1,5</sup>. Dept of Clin Pharmacol, St. Vincent's Hospital<sup>1</sup>, Sydney, NSW; School of Med Sci, Univ of NSW<sup>2</sup>, Kensington, NSW; Dept of Nephrol, St. Vincent's Hospital<sup>3</sup>, Sydney, NSW; Dept Endocrin, St. Vincent's Hospital<sup>4</sup>, Sydney, NSW; St. Vincent's Clinical School, Univ of NSW<sup>5</sup>, Kensington, NSW.

**Introduction.** The cardioprotective effects of the anti-hyperglycaemic agent metformin may be of great benefit to patients with type 2 diabetes mellitus (T2DM) and end-stage kidney disease (ESKD) who require haemodiafiltration (HDF). Metformin is extensively cleared from plasma during HDF (Smith et al, 2016). This indicates that metformin may be safely given to these patients if administration matches extraction during HDF, thereby preventing metformin accumulation and lactic acidosis. Further studies are required to confirm this.

**Aims.** To monitor the safety of metformin in patients with T2DM and ESKD undergoing HDF.

**Methods.** Patients received metformin (1R, 250 mg) after each HDF session (thrice weekly; 750 mg/week) for 6 months. Regular blood samples were collected prior to the start of HDF to monitor safety parameters (plasma lactate <5 mmol/L, plasma metformin <5 mg/L). Metformin concentrations were quantified by HPLC.

**Results.** Plasma lactate concentrations remained below 5 mmol/L in all patients (n=7) for the duration of treatment. Plasma metformin concentrations remained below 5 mg/L, except for 2 occasions in Patient 3 (max=5.3 mg/L). Unfortunately, Patients 1 and 6 passed away from cardiac events in the fourth month of the study. The study was subsequently ceased by local governance. No safety data from these patients was suggestive of lactic acidosis.

**Discussion.** Cardiovascular disease is the leading cause of death in HDF patients. Additionally, there is no evidence to date that associates metformin with an increased risk of cardiovascular events. Prior to study cessation, all data collected supported the safety of metformin in HDF. This information, particularly given the safety data collected from Patients 1 and 6, suggests it is unlikely that metformin contributed to these deaths. Regardless, further studies are required to investigate any potentially deleterious interactions between metformin and the rapid shifts in biochemistry and body fluid that take place during HDF.

Smith F et al (2016) Am J Kidney Dis 68:990-992

**219 Neuronal calcium sensor-1 (NCS-1) in the regulation of calcium homeostasis and cell death in MDA-MB-231 basal breast cancer cells**

Alice HL Bong<sup>1</sup>, John J. Bassett<sup>1</sup>, Sarah J Roberts-Thomson<sup>1</sup>, Michael J. G. Milevskiy<sup>2</sup>, Gregory R. Monteith<sup>1,3</sup>. School of Pharmacy, The University of Queensland<sup>1</sup>, Brisbane, QLD, Australia; The Walter and Eliza Hall Institute of Medical Research<sup>2</sup>, Melbourne, VIC, Australia; Mater Research, The University of Queensland<sup>3</sup>, Brisbane, QLD, Australia.

**Background:** Altered calcium (Ca<sup>2+</sup>) signalling in cancer cells may promote cancer hallmarks such as resistance to apoptosis. Proteins regulating these signals represent attractive therapeutic targets. Neuronal calcium sensor-1 (NCS-1) is associated with tumour aggression and poor prognosis in breast cancer patients. However, the characterisation of NCS-1 in breast cancer molecular subtypes, the effects of NCS-1 silencing on intracellular Ca<sup>2+</sup> homeostasis in breast cancer cells and on the cytotoxic effect of the anti-cancer drug doxorubicin, remain unexplored.

**Aim:** To assess the expression of NCS-1 in public breast cancer datasets and assess the consequences of silencing NCS-1 on intracellular Ca<sup>2+</sup> signaling and sensitivity to doxorubicin in the MDA-MB-231 basal breast cancer cell line.

**Methods:** The expression of NCS-1 in patient breast tumours was stratified by PAM50 molecular subtype and assessed using breast cancer public datasets. MDA-MB-231 cells stably expressing the GCaMP6m Ca<sup>2+</sup> sensor were transfected with non-targeting control or NCS-1 siRNA. The effects of NCS-1 silencing on cytosolic Ca<sup>2+</sup> in response to Ca<sup>2+</sup>-mobilising agonists (ATP, trypsin and cyclopiazonic acid (CPA)) and on constitutive Ca<sup>2+</sup> influx were measured using a Fluorescent Imaging Plate Reader (FLIPR). The sensitivity to doxorubicin (24 h) following gene silencing of NCS-1 was determined by propidium iodide staining.

**Results:** NCS-1 was expressed higher in basal molecular subtype breast cancers. Silencing NCS-1 did not alter cytosolic Ca<sup>2+</sup> changes induced by ATP, trypsin or CPA treatment. However, NCS-1 silencing suppressed constitutive Ca<sup>2+</sup> influx. NCS-1 silencing also promoted MDA-MB-231 cell death in combination with doxorubicin (1 µM) treatment.

**Discussion:** These results implicate NCS-1 in basal breast cancer, a subtype with poor prognosis. Indirect modulators of endoplasmic reticulum Ca<sup>2+</sup> levels such as NCS-1 may alter constitutive Ca<sup>2+</sup> influx pathways and influence processes important in cancer such as sensitivity to anti-cancer agents.

Monteith GR et al (2017) Nat Rev Cancer. 17:367-380.

Moore LM et al (2017) Mol Cancer Res. 15(7); 942-952

## 220 The Relationship Between Busulphan AUC and the Incidence of Sinusoidal Obstruction Syndrome in Haematopoietic Stem Cell Transplants

Parth J Upadhyay<sup>1</sup>, Janna Duong<sup>1</sup>, Christa Nath<sup>2</sup>, Peter Shaw<sup>2</sup> and Alan V Boddy<sup>1</sup>, <sup>1</sup>University of Sydney, NSW, Australia, <sup>2</sup> The Children's Hospital at Westmead, NSW, Australia

**Introduction:** High dose busulphan (Bu) is an essential component of myeloablative regimens prior to Haematopoietic Stem Cell Transplantation (HSCT), but is subject to significant inter- and intra-individual pharmacokinetic variability, which is a challenge for accurate dosing within the therapeutic window. Furthermore, sinusoidal obstruction syndrome (SOS) remains a major toxicity of Bu overexposure despite the addition of prophylaxis to the chemotherapy regimen.

**Aim:** To investigate the relationship between Bu exposure (cumulative area under the curve, AUC) and the incidence of SOS in paediatric patients.

**Methods:** Data from 131 individuals receiving Bu prior to HSCT (2006-2017) from the Children's Hospital at Westmead was used. Population pharmacokinetic analysis of Bu was performed (one-compartment model, NONMEM®) and associations with SOS were evaluated using the unpaired *t*-test ( $P < 0.05$ ).

**Results:** The data included patients, aged from 44 days to 23 years old, receiving Bu for 34 different immune, haematological and oncology conditions (30 different protocols prior to transplantation). There was a large variability in Bu clearance (0.78-13.06 L/h, range) and cumulative AUC (29.41-130.39 mg·h/L), with no significant differences between patients with or without SOS ( $P = 0.13$ ). The incidence of SOS was 27% and median onset time was 12 days (5 to 31 days) post-transplant.

**Discussion:** There was no distinction in the cumulative AUC for patients with or without SOS but there was a large proportion of patients who were out of the targeted cumulative AUC of 56-86 mg·L/h (Figure). Based on these findings, variation in Bu AUC alone does not explain the incidence of SOS.

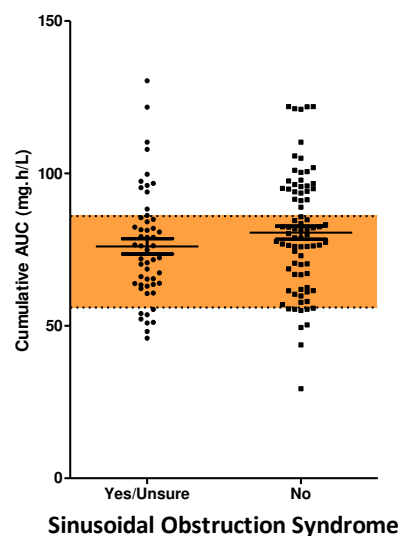

## 221 An investigation of the vascular effects of Sailuotong, a standardised Chinese herbal formula, for vascular dementia

Seungyeon Yeon<sup>1</sup>, Dennis Chang<sup>1</sup>, Hosen Kiat<sup>1,2,3</sup>, Alan Bensoussan<sup>1</sup> and Sai Wang Seto<sup>1</sup>, <sup>1</sup>NICM, School of Science and Health, Western Sydney University<sup>1</sup>, Campbelltown, NSW, Australia. <sup>2</sup>Faculty of Medicine, University of New South Wales, NSW, Australia. <sup>3</sup>Faculty of Medicine and Health Sciences, Macquarie University, NSW, Australia

**Introduction.** Sailuotong (SLT) is standardised three-herb formulation consisting of *Panax ginseng C A Mey*, *Ginkgo biloba L* and *Crocus sativus L* for the management of vascular dementia (VaD). Although SLT has been shown to increase cerebral blood flow in animal and clinical studies, the direct effects of SLT on vascular reactivity have not investigated.

**Aims.** To examine the vasodilatory effects of SLT and its underlying mechanisms of action in rat isolated tail artery.

**Methods.** Male, 250-300g Wistar Kyoto (WKY) rat-tail artery was isolated for isometric tension measurement.

**Results.** Cumulative administration of SLT (0.1 – 5000 µg/mL) caused a concentration-dependent relaxation in phenylephrine-precontracted tail artery. Pre-incubation of endothelium nitric oxide synthase inhibitor (N-nitro-L-arginine methyl ester, L-NAME; 20 µM) did not inhibit the SLT-induced vasodilatation. In contraction experiments, SLT (10, 100 and 1000 µg/mL) significantly attenuated phenylephrine (0.001 to 10 µM)- and KCl (10 – 80 mM)-induced contraction. In Ca<sup>2+</sup>-free solution, SLT (5000 µg/mL) markedly suppressed Ca<sup>2+</sup>-induced (0.001 – 3 mM) vasoconstriction in both phenylephrine (10 µM) and KCl (80 mM) stimulated tail arteries.

**Discussion.** Putting these together, our results suggested that SLT induces relaxation of rat isolated tail arterial rings through an endothelium-independent pathway, involving blockade of extracellular Ca<sup>2+</sup> influx.

**222 The Medication Regimen Simplification Guide for Residential Aged CarE (MRS GRACE): a novel tool to optimise medication regimens for residents of aged care facilities.**

Esa YH Chen<sup>1,2</sup>, Janet K Sluggett<sup>1,2</sup>, Jenni Ilomäki<sup>1</sup>, Sarah N Hilmer<sup>2,3</sup>, Megan Corlis<sup>2,4</sup>, J Simon Bell<sup>1,2</sup>, MRS GRACE development group. Ctr for Med Use and Saf, Monash Univ<sup>1</sup>, Parkville, VIC, Australia; NHMRC Cog Dec Partn Ctr, Hornsby Ku-ring-gai Hosp<sup>2</sup>, Hornsby, NSW, Australia; Kolling Instit, Univ of Sydney<sup>3</sup>, St Leonards, NSW, Australia; Helping Hand Aged Care<sup>4</sup>, North Adelaide, SA, Australia.

**Introduction.** Residents of aged care facilities use increasingly complex medication regimens. Reducing unnecessary medication regimen complexity (e.g. by consolidating number of administration times or using alternative formulations) may benefit staff administering medications and residents taking medications.

**Aims.** To develop and validate an implicit tool to facilitate medication regimen simplification in aged care facilities.

**Methods.** A purposively-selected multidisciplinary expert panel used modified nominal group technique to identify and prioritise factors important in determining whether a medication regimen can be simplified. The five prioritised factors were formulated as questions, pilot-tested using non-identifiable medication charts and refined by panel members. The final tool was validated by two clinical pharmacists who independently applied the tool to medication charts for a random sample of 50 residents to identify opportunities for medication regimen simplification. Inter-rater agreement was calculated using Cohen's kappa.

**Results.** The Medication Regimen Simplification Guide for Residential Aged Care (MRS GRACE) was developed as an implicit tool and accompanying explanatory statement. The tool comprises five questions related to resident and facility related factors, drug interactions, and formulation. Using MRS GRACE, two pharmacists independently simplified medication regimens for 29/50 and 30/50 residents (Cohen's kappa=0.38, 95%CI 0.12-0.64), respectively. Simplification was possible for all residents with five or more administration times. Changing an administration time comprised 75% of the two pharmacists' recommendations.

**Discussion.** By applying MRS GRACE, two clinical pharmacists independently simplified two-thirds of residents' medication regimens with fair agreement. MRS GRACE is a promising new tool to guide medication regimen simplification in aged care facilities.

**223 Behavioural, pharmacologic and histologic characterisation of a rat model of mechanical low back pain**

Thomas S W Park<sup>1</sup>, Andy Kuo<sup>1</sup>, Maree T Smith<sup>1,2</sup>. CIPDD, The Univ of Queensland<sup>1</sup>, Brisbane, QLD, Australia; School of Pharmacy, The Univ of Queensland<sup>2</sup>, Brisbane, QLD, Australia.

**Introduction.** Low back pain (LBP) is a common health problem affecting humans globally. Hence, I have used behavioural, histological and pharmacological methods to characterise an optimised rat model of mechanical LBP established at the CIPDD.<sup>1</sup>

**Aims.** To use behavioural, histological and pharmacological methods to characterise our new rat model of mechanical LBP.

**Methods.** Ten small punctures (0.5 mm o.d.; 2 mm deep) were induced in the L4/L5 and L5/L6 intervertebral discs (IVDs). Sham rats had the same surgery but there was no IVD puncture. Pressure algometry thresholds (PATs) at L4/5 and L1 were assessed. Additionally, paw withdrawal thresholds (PWTs) were measured in the bilateral hindpaws using calibrated von Frey filaments. PATs and PWTs were measured at weekly intervals until study completion. Dosing solutions of morphine (0.1, 0.3, and 1.0 mg/kg; sc), gabapentin (30, 60, and 100 mg/kg; ip), amitriptyline (1, 3, and 7 mg/kg; ip), meloxicam (3, 10, and 30 mg/kg; ip) and vehicle (2 mL/kg; ip) were administered to rats by the first person and testing was undertaken in a 'blinded' manner by the second person. Both LBP and sham rats were also characterised using histologic methods.

**Results.** Mechanical hyperalgesia developed progressively at L4/L5 and L1 in LBP-rats but not sham-rats. Importantly, PWTs remained unaltered for the study period. Histological analysis of the IVDs from LBP-rats showed an apparent loss of sharp boundaries between the nucleus pulposus and annulus fibrosus. In LBP-rats, single bolus doses of morphine produced dose-dependent relief of primary and secondary mechanical hyperalgesia in the lumbar axial deep tissues at L4/L5 and L1, respectively, whereas gabapentin, amitriptyline, meloxicam and vehicle were inactive.

**Discussion.** We have characterised a new rat model of chronic mechanical LBP using behavioural, pharmacologic and histologic methods.

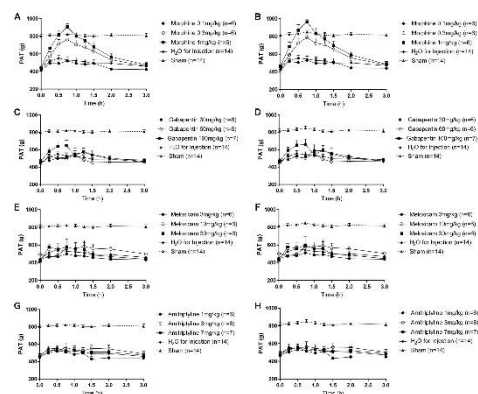

<sup>1</sup>Muralidharan A, Park TSW et al (2017) Front Pharmacol 8:493

**224 Understanding the physiological role of endogenous allosteric modulators in the muscarinic acetylcholine receptors**

Ee Von Moo, Patrick M Sexton, Arthur Christopoulos and Celine Valant. Drug Discovery Biology, Monash Institute of Pharmaceutical Science, Monash University, Parkville, VIC, Australia.

**Introduction.** Allosteric binding sites on G protein-coupled receptor (GPCR) can be targeted by synthetic or natural (endogenous) molecules (van der Westhuizen et al., 2015). However, the (patho)physiological role(s) of many endogenous allosteric modulators remain poorly understood. One interesting example is major basic protein (MBP), a highly basic peptide that acts as a negative allosteric modulator (NAM) of acetylcholine (ACh) at airway M<sub>2</sub> muscarinic acetylcholine receptors (mAChR; Jacoby et al., 1993). We hypothesized that, in addition to MBP, other endogenous basic peptides, including the antimicrobial, LL-37, involved in chemotaxis, maturation of immune cells and apoptosis (Kahlenberg et al., 2013) could also interact allosterically with the M<sub>2</sub> mAChRs and have major physiological impacts.

**Aims.** To characterise the pharmacological properties and the putative (patho)physiological roles of LL-37 at mAChRs.

**Methods.** Using IMR-32, a native cell line endogenously expressing human M<sub>2</sub> mAChRs and mouse tissues predominantly expressing mouse M<sub>2</sub> mAChRs, we performed [<sup>3</sup>H]NMS radioligand binding and [<sup>35</sup>S]GTPγS turnover as a functional measure of receptor activation, to assess the allosteric effect of LL-37.

**Results.** LL-37 mediated a concentration-dependent partial inhibition of the antagonist [<sup>3</sup>H]NMS binding in IMR-32 cells and mouse cardiac tissues (pK<sub>B</sub>=4.7±0.3 and 5.6±0.5, respectively), a hallmark of allostery. Additionally, LL-37 also negatively modulated ACh-mediated G protein activation in mouse hypothalamus preparations.

**Discussion.** Our results suggest that LL-37 is a NAM of antagonist binding and agonist function at the M<sub>2</sub> mAChR. The M<sub>2</sub> mAChRs are highly expressed on both neuronal and non-neuronal cells, including immune cells and epithelial cells, and are known to be involved in their survival outcome. In the context of inflammation and cancer, when LL-37 is highly expressed, the antagonism of M<sub>2</sub> mAChR activity by the peptide could therefore have unappreciated (patho)physiological consequences.

van der Westhuizen ET al. (2015) J Pharm Exp Ther 353(2):246-60.

Jacoby et al. (1993) J Clin Invest 91:1314-1318.

Kahlenberg et al. (2013) J Immunol 191(10):4893-901.

**225 Microdosed cocktail of apixaban, edoxaban and rivaroxaban can predict drug interaction with therapeutic doses**

Gerd Mikus, Marlene Schaumäker, Kathrin Foerster, Marie-Louise Lehmann, Walter Emil Haefeli, Dept Clinical Pharmacology and Pharmacoepidemiology, University Hospital, Heidelberg, Germany

**Introduction:** The direct oral anticoagulants (DOAK) apixaban, edoxaban, and rivaroxaban are factor Xa inhibitors and plasma concentrations predict the pharmacological effect.

**Aims:** In order to facilitate more knowledge for the decision which one to use in individual patients with their comedication, we explored the use of a microdosed cocktail of the 3 DOAKs. The effect of ketoconazole on the pharmacokinetics of normal doses has already been studied.

**Methods:** This randomised study was approved by the competent authority and the ethics committee. Eighteen participants took the DOAK cocktail alone or in combination with ketoconazole (400mg qd, starting 1 day before the DOAK administration). Solutions of the DOAKs were prepared by the hospital pharmacy. Final drinking solution of apixaban (25µg), edoxaban (50µg), and rivaroxaban (25µg) were prepared just before intake. A 2 day pharmacokinetic profile was obtained. Plasma concentrations of microdosed apixaban, edoxaban, and rivaroxaban were quantified using an according to FDA & EMA guidelines validated ultra-performance liquid chromatography-tandem mass spectrometry (UPLC-MS/MS) assay with a LLOQ of 2.5 pg/ml.

**Results:** Simultaneous administration of the DOAK cocktail shows similar pharmacokinetic data compared to published data using a normal therapeutic dose. Ketoconazole significantly increased AUC of all 3 DOAKs with an AUCR of 1.90 (apixaban), 2.35 (edoxaban), and 2.27 (rivaroxaban).

**Discussion:** Literature data of ketoconazole and normal doses of apixaban, edoxaban, and rivaroxaban showed an increase by 1.99, 1.87, and 2.58 (steady-state), respectively. Hence, the microdosed cocktail approach is able to predict the drug interaction with ketoconazole precisely. To study drug interaction with a drug class only one study has to be carried out and no pharmacological effects occur due to the microdosing approach.

Mueck W et al (2013) Br J Clin Pharmacol 76:455-66

Frost CE et al (2015) Br J Clin Pharmacol 79:838-46

Zahir HMJ et al (2014) Clin Pharm Drug Suppl 1:1-59

**226 The influence of ABCG2 genotype on allopurinol dose predictions**

Daniel FB Wright<sup>1</sup>, Amanda Phipps-Green<sup>2</sup>, Tony R Merriman<sup>2</sup>, Murray L Barclay<sup>3</sup>, Nicola Dalbeth<sup>4</sup>, Lisa K Stamp<sup>3</sup>, <sup>1</sup>School of Pharmacy, <sup>2</sup>Department of Biochemistry, University of Otago, Dunedin, New Zealand, <sup>3</sup>Department of Medicine, University of Otago, Christchurch, New Zealand, <sup>4</sup>Department of Medicine, University of Auckland, Auckland, New Zealand

**Introduction:** A genetic variant in the urate transporter ABCG2 (p.Lys141) has been associated with poor allopurinol response in gout patients. Tools designed to predict allopurinol dose requirements do not account for ABCG2 genetics.

**Aims:** To evaluate the influence of ABCG2 genotype (*rs2231142*) on the performance of two dosing tools for allopurinol therapy (Wright 2016, Graham 2013 - termed the 'Otago' and 'Sydney' models).

**Methods:** Allopurinol maintenance dose predictions were compared to the observed dose required to achieve a serum urate of < 0.36mmol/L in an external cohort of n=413 patients (Stamp et al 2017) using mean prediction error (MPE). MPE for the poor-response genotypes (GT/TT) for ABCG2 (*rs2231142* G>T) was compared to the GG genotype using a Students t-test. The variability in prediction error (PE) explained by ABCG2, other transporter genotypes, patient factors, and concomitant drugs was quantified using multi-linear regression.

**Results:** Allopurinol doses were over-predicted by both the Otago and Sydney dosing tools (MPE 150mg/day and 140 mg/day, respectively). ABCG2 genotype significantly influenced dose predictions from the Otago (MPE 201 mg/day [GG] and 88 mg/day [GT/TT], p<0.0001) and Sydney models (MPE 207 mg/day [GG] and 65 mg/day [GT/TT], p=0.0103). When examined in isolation, the TT genotype (n=15) lead to unbiased dose predictions (MPE 15 mg/day, 95% CI -99-129 and 25mg/day 95% CI -181-231). ABCG2 genotype and diuretic use explained 55% of the variability in PE (adjusted R<sup>2</sup>=0.55, p=0.0002). The GT/TT genotype effect reduced PE by 90mg/day (p=0.032).

**Discussion:** ABCG2 *rs2231142* appears to have a significant influence on allopurinol dose predictions. Any future updates to the dosing tools will need to incorporate the influence of ABCG2 genotype on allopurinol dose requirements.

Wright DFB et al (2016) Br J Clin Pharmacol 81(2):277-89

Graham et al (2013) Br J Clin Pharmacol 76(6):932-8

Stamp LK et al (2017) Ann Rheum Dis; 76:1522–1528

**227 Late onset rise of 6-MMP metabolites in inflammatory bowel disease patients on azathioprine or mercaptopurine**

Murray L Barclay<sup>1,2</sup>, Erik Munnig-Schmidt<sup>3</sup>, Mei Zhang<sup>1</sup>, Chris J Mulder<sup>3</sup>, <sup>1</sup>Dept of Medicine, Univ of Otago Christchurch, Christchurch, <sup>2</sup>Depts of Gastroenterol and Clin Pharmacol, Christchurch Hospital, Christchurch, New Zealand, <sup>3</sup>Dept of Gastroenterol, VU Medical Centre, Amsterdam, The Netherlands

**Introduction:** The thiopurines azathioprine and mercaptopurine remain pivotal in maintenance treatment in inflammatory bowel disease, however up to 15-20% of patients preferentially produce the hepatotoxic metabolite 6-methylmercaptopurine (6MMP) at the expense of the main therapeutic metabolites 6-thioguanine nucleotides (6TGN). This metabolic shunting usually occurs within 3 months of therapy, but we noted patients developing shunting many months or years after starting treatment.

**Aims:** To determine how often this late shunting occurs and whether this could be explained by patient factors, or concomitant medications.

**Methods:** The New Zealand national database of thiopurine metabolite results from 2002 to 2016 (19085 6TGN/6MMP pairs from 7130 patients) was interrogated to identify patients developing preferential 6MMP production, as defined by 6MMP/6TGN ratio >20, after more than four months of treatment. Dosing history, concomitant therapy and comorbidity data were assessed.

**Results:** Fifteen percent of all patients in the database developed preferential 6-MMP production and of these, we found 29 patients with late onset of preferential 6MMP production with sufficient medical data available to validate this. This equates to an estimate of 90 patients if all data had been available, representing 1.7% of IBD patients on thiopurines, or 10% of all those with preferential 6-MMP production. Time from starting therapy to shunting was 5 months to 10.4 years (median 21 months). Eleven patients had abnormal liver function when shunting was recognised, all with 6MMP >5900 pmol/8x10<sup>8</sup> RBCs. No common factors were found to explain the late occurrence of shunting.

**Discussion:** A group of IBD patients develop preferential 6MMP production many months or years after commencing therapy. This is important to recognise when considering frequency of metabolite monitoring and when considering failure of therapy, or abnormal liver function.

**228 Minimising the Functional Burden of Medications in Older Inpatients: Implementation of the Drug Burden Index**

Rayan Nahas<sup>1,2</sup>, Danijela Gnjidic<sup>1</sup>, Terry Finnegan<sup>1</sup>, Emily Reeve<sup>1</sup>, Jenny Crane<sup>2</sup>, Lisa Kouladjian O'Donnell,<sup>1</sup> Sarah N Hilmer<sup>1</sup>  
<sup>1</sup>Kolling Institute, Royal North Shore Hospital, Sydney, NSW, Australia, <sup>2</sup>Pharmacy Department, Royal North Shore Hospital, Sydney, NSW, Australia

**Introduction:** The Drug Burden Index (DBI) is a score that measures exposure to anticholinergic and sedative medications.

**Aims:** This study investigated the impact of a pharmacist-led intervention on changes in DBI score at discharge and clinical outcomes in older inpatients.

**Methods:** Patients over 70 years admitted to a tertiary referral hospital under medical services, and taking at least one DBI medication were recruited, and randomised to intervention or control arms. In the intervention group, on admission the pharmacist calculated DBI score using the DBI Calculator<sup>®</sup> and discussed the report and their recommendations with the treating team. The control group received usual care. Primary outcome was proportion of patients in whom DBI was decreased, unchanged or increased at discharge (chi-squared analysis, SPSS<sup>®</sup>). This study was approved by the institutional ethics committee and registered by the online registry of clinical trials.

**Results:** Intervention (n=122) and control groups (n=131) both had a median age of 85 years, with similar prevalence of females (59.8% intervention and 55.7% control) and frailty (68.9% intervention and 61.1% control) which was not statistically significant (P>0.05). More patients were from aged care facilities in the intervention group (18.7% vs 9.9%; P>0.05). Mean  $\pm$  SD baseline DBI score was 1.08 $\pm$ 0.67 in the intervention and 0.98 $\pm$ 0.65 in the control group. DBI score was decreased during admission for 67.8% of participants in the intervention and 29.2% in the control group (P<0.001). Fewer new adverse drug events were reported in intervention (20.2%) compared to control group (34.4%; P<0.01). There was no significant difference between groups in length of stay, falls, pressure areas or mortality during hospitalisation. The mean  $\pm$  SD time the pharmacist spent per participant to conduct the intervention was 6.09 $\pm$ 3.03 minutes.

**Discussion:** An intervention targeting older inpatients' DBI scores significantly decreased DBI exposure on discharge with no significant adverse effects. Future analyses will investigate prescribing and clinical outcomes six months after discharge.

**229 A stimulation study to assess the possible contribution of measurement error in quetiapine depression trials**

Jia Ning Careen Tan<sup>1</sup>, Holly Foot<sup>1</sup>, Christine Staats<sup>1</sup>, Karl Winckel<sup>1,2</sup>, Adam La Caze<sup>1</sup>, <sup>1</sup>School of Pharmacy, University of Queensland, Brisbane, QLD, <sup>2</sup>Princess Alexandra Hospital, Brisbane, QLD

**Introduction:** There is concern that the inclusion of somatic items in depression rating scales may lead to measurement error in the assessment of depression; e.g. the scale may be influenced by a side effect of treatment such as sedation rather than an improvement in affect (Komossa et al, 2010). Quetiapine causes sedation and has randomised trial data claiming significant benefit against major depressive disorder (Bortnick et al,2011).

**Aim:** To assess the possible contribution of measurement error to the assessment of quetiapine as the treatment of depression.

**Methods:** We used data from quetiapine depression trial (Bortnick et al,2011) to undertake a simulation study that attempts to isolate the effects of quetiapine on sleep. We simulated 10,000 trials comparing quetiapine, Drug A and Drug B with placebo. Drug A was a fictional drug that has placebo effect combined with the sedative effects of quetiapine and Drug B was a fictional drug that has all effects of quetiapine except the sedative effects. Each trial compared the response rate for the drug against with placebo using Fisher's Exact Test. Simulations were conducted under the assumption that drug and placebo effects are evenly distributed throughout the sample.

**Results:** The presence or absence of quetiapine's sedative effects (Drug A, Drug B) influences the likelihood of trial success (Table 1). Relaxing the assumption that drug and placebo effects are evenly distributed has a disproportionate effect on placebo response rate and reduces the likelihood of successful trials (especially for Drug A).

**Discussion:** The beneficial effects of quetiapine on depression may not be explained by its sedative side effects alone. The contribution of measurement error in assessment of antidepressant efficacy needs further attention.

Table 1: Percent of successful trials in each drug group

Comparators	Percent of successful trials (%)
Quetiapine vs Placebo	98.55
Drug A vs Placebo	27.53
Drug B vs Placebo	85.06

Bortnick B et al (2011) J of Affective Disorders 128:83-94

Komossa K et al (2010) Cochrane Database Syst Rev 12:CD008121

**230 A Multicentre Open-Label Pharmacokinetic-Pharmacodynamic Study of Febuxostat in Patients with Chronic Gout**

Bishoy Kamel<sup>1,2</sup>, Garry G Graham<sup>1,2</sup>, Kenneth M Williams<sup>1,2</sup>, Sophie L Stocker<sup>2,3</sup>, Jane E Carland<sup>2,3</sup>, Kevin D Pile<sup>4</sup>, Louis E McGuigan<sup>5</sup>, Ian J Portek<sup>6</sup>, Neil W McGill<sup>7</sup>, Richard O Day<sup>1,2,3</sup>, <sup>1</sup>School of Med Sc, Univ of New South Wales, <sup>2</sup>Dept of Clin Pharmacol and Toxicol, St Vincent's Hosp, <sup>3</sup>St Vincent's Clin School, Univ of New South Wales, <sup>4</sup>Dept of Med, Western Sydney Univ, <sup>5</sup>Dept of Rheum, Narrabri Hosp, <sup>6</sup>Dept of Rheum, St George Hosp, <sup>7</sup>Dept of Med, Univ of Sydney

**Introduction:** There are conflicting data concerning the effect of renal function on the pharmacokinetics and response to febuxostat (Fbx).

**Aims:** To explore relationships between the concentrations of serum urate (SU) and plasma Fbx in patients with chronic gout and examine the influence of renal function on the plasma concentrations of Fbx and the efficacy of Fbx.

**Methods:** Baseline demographics including SU and serum creatinine concentrations were collected. Plasma Fbx concentrations and SU were measured at four times during long term treatment with Fbx over the dosage interval (24 h). Data is presented as mean  $\pm$  S.D.

**Results:** Chronic gout patients (20 males, 6 females) were recruited. The duration of Fbx treatment (40-120 mg/day) was 6 weeks to 66 months. Baseline SU and eGFR were  $0.59 \pm 0.09$  mmol/L and  $61 \pm 24$  mL/min, respectively. Fbx 40 (n=8), 80 (n=17) and 120 (n=5) mg/day achieved similar reductions of SU;  $0.34 \pm 0.09$ ,  $0.36 \pm 0.11$  and  $0.31 \pm 0.07$  mmol/L, respectively. Target SU  $\leq 0.36$  and  $\leq 0.30$  mmol/L were achieved by 90% (24/26) and 77% (20/26) of patients, respectively, with Fbx doses of up to 120 mg/day. At Fbx 80 mg daily, the reduction in SU was  $0.37 \pm 0.09$  and  $0.34 \pm 0.13$  mmol/L in patients with eGFR  $< 60$  (n=9) and  $\geq 60$  (n=8) mL/min, respectively. At Fbx dosage of 80 mg daily, trough concentrations of Fbx were significantly higher in patients with eGFR  $< 60$  mL/min ( $0.17 \pm 0.11$ ) than those with eGFR  $\geq 60$  mL/min ( $0.03 \pm 0.01$ ) (P= 0.009). Renal function had no significant effect on peak Fbx concentrations. There was a 50-fold fluctuation in plasma Fbx over 24 h while SU did not fluctuate significantly over this time.

**Discussion:** Higher trough Fbx concentrations in patients with eGFR  $< 60$  mL/min may be due to the retention of Fbx-glucuronide and the subsequent regeneration of the parent drug. Renal function does not influence the hypouricaemic response to Fbx. We suggest that the small fluctuation in SU over 24 h is due to the long half-life of urate (20 to 30 h). A larger sample size is required to confirm present results.

**231 The safety and pharmacokinetics of metformin in heart failure**

Gina Chowdhury<sup>1</sup>, Felicity C Smith<sup>1</sup>, Peter S Macdonald<sup>2</sup>, Jane E Carland<sup>1</sup>, Sophie L Stocker<sup>1</sup>, Shaun S Kumar<sup>3</sup>, Jerry R Greenfield<sup>4</sup>, Kenneth M Williams<sup>1</sup>, Garry G Graham<sup>1</sup>, Richard O Day<sup>1</sup>, <sup>1</sup>Dept of Clin Pharmacol, St. Vincent's Hosp, School of Med Sci, Univ of NSW, Sydney, NSW, Australia, <sup>2</sup>Heart Transplant Unit, St Vincent's Hosp, Sydney, NSW, Australia, <sup>3</sup>Div Clin Pharmacol, Dept Ped, Univ of Utah, UT, USA, <sup>4</sup>Dept Endocrin, St Vincent's Hosp, Sydney, NSW, <sup>5</sup>St Vincent's Clinical School, Univ of NSW, Kensington, NSW

**Introduction:** Metformin, a type II diabetes (T2DM) drug, is contraindicated in heart failure (HF) in Australia due to a perceived increased risk of lactic acidosis. The safety of metformin in HF, described in epidemiological studies, has facilitated approval of its use in HF patients in the US, UK, Canada and New Zealand. Detailed prospective data on the safety and PK of metformin is required to confidently remove this contraindication in Australia.

**Aim:** To explore the safety and PK of metformin in HF patients and compare with healthy subjects (Timmins et al, 2005) and T2DM patients without HF (T2DM Control) (Duong et al, 2013)

**Methods:** This cross-sectional study consisted of two cohorts of HF subjects; those with T2DM receiving metformin (n=10), and those without T2DM and metformin naïve (n=26). Biochemical parameters (including lactate, anion gap and bicarbonate) and plasma metformin concentrations were determined. Metformin PK parameters were determined using NONMEM.

**Results:** In HF patients with T2DM, plasma lactate, anion gap and bicarbonate concentrations did not correlate with plasma metformin concentrations. The apparent CL of metformin ( $37 \pm 17$  L/h) was similar to the T2DM patients ( $49 \pm 26$  L/h), but significantly lower than healthy subjects ( $75 \pm 14$  L/h; p <0.05). The peripheral V was significantly lower in HF patients compared to healthy subjects (p=0.04). Lactate concentrations of HF patients without T2DM ( $1.5 \pm 0.7$  mmol/L) were significantly lower than in T2DM patients with or without HF ( $1.9 \pm 0.9$  mmol/L; p <0.05).

**Discussion:** The PK of metformin in T2DM HF patients are similar to those in T2DM patients without HF. Additionally, hyperlactatemia was not associated with HF patients both with and without T2DM. These results provide the support for a larger interventional study with metformin in HF patients.

Duong JK et al (2013) Clin Pharmacokinet 52:373-384

Timmins P et al (2005) Clin Pharmacokinet 44: 721-729

**232 Vignettes from hospital-level electronic prescribing data**

Paul KL Chin<sup>1,2</sup>, QianYi Chuah, Matt P Doogue<sup>1,2</sup>, <sup>1</sup>Department of Clinical Pharmacology, Canterbury District Health Board, Christchurch, NZ, <sup>2</sup>Department of Medicine, University of Otago, Christchurch, NZ

**Introduction:** Canterbury District Health Board (CDHB) have rolled out the electronic prescribing and administration (ePA) software, MedChart™, to 1354 hospital beds as of December 2016. Data from these medication charts can be used to monitor user behaviour, and to inform design and evaluate MedChart clinical decision support (CDS) tools.

**Aims:** To describe a sample of CDHB MedChart analyses that are used clinically.

**Methods:** Data for 1/1/2017-30/6/2017 were extracted and parsed from the CDHB MedChart database with data cleaning and analytics using R and Tableau. The data requirements were specified by the CDHB CDS Working Group and analysed by the medicines utilisation review (MUR) team.

**Results:** There was a median (range) of 74,418 (70,868 to 84,174) prescriptions per month.

- 1) Medical student prescribing: A median (range) of 5 (2-14) prescriptions per month were 'signed' by medical students. Students should not be 'signing' prescriptions; feedback was provided to each student.
- 2) MedChart prescribing method: In 22 patients admitted for upper gastrointestinal bleeding, the use of protocol prescriptions were associated with more administrations of intravenous omeprazole than 'long-hand' prescriptions (median 12 vs 8 administrations,  $p = 0.0125$ ). Local guidelines stipulate 12 administrations. The use of preformatted protocol prescriptions facilitates implementation of guidelines.
- 3) Overdose prevention: Of 518 spironolactone prescriptions, 415 (80%) involved doses up to 25 mg, with the remainder between 37.5 and 200 mg. This informed the setting for the spironolactone high-dose alert.
- 4) Drug-drug interaction warnings: Alerts fired 34 times against the combined prescribing of enoxaparin and dabigatran, with 25 (74%) associated with changes to the antithrombotic prescriptions. This combination has been associated with major bleeding events.
- 5) Adverse drug reactions (ADRs) recording: Of 29,714 ADRs, 5,719 (19%) were against drug classes, and 4,875 (16%) were against brand names. ADRs should be recorded against generic names to facilitate recognition by MedChart and users.

**Discussion:** Integrated MUR and CDS teams can effectively utilise ePA data to improve the use of ePA.

**233 Identifying clinical pharmacist patient prioritisation criteria**

Nazanin Falconer<sup>1</sup>, Michael Barras<sup>1,2</sup>, Neil Cottrell<sup>1</sup>, <sup>1</sup>School of Pharmacy, The University of Queensland, Brisbane, QLD, Australia, <sup>2</sup>Department of Pharmacy, Princess Alexandra hospital, Brisbane, QLD, Australia

**Introduction:** An estimated 7% of hospitalised patients experience serious medication harm and 0.3% die due to an adverse drug event (ADE). In increasingly busy hospitals, with high patient throughput and scarce resources, identifying patients at high-risk of ADEs is crucial to enable early and targeted clinical pharmacist intervention.

**Aims:** To determine key criteria used by clinical pharmacists to identify and prioritise high-risk patients.

**Methods:** Clinical pharmacists at the Princess Alexandra Hospital were invited to participate in focus groups designed to elicit their perspectives and approaches when prioritising patients for clinical pharmacy services. Seeding questions and clinical vignettes were used to identify their key criteria.

**Results:** Twenty clinical pharmacists took part in four, one-hour, audio recorded focus groups. Pharmacists used a combination of criteria to determine patient priority. These included: reason for admission (e.g. acute kidney injury and atrial fibrillation), complex co-morbid conditions (e.g. patients with cardiovascular disease, diabetes and mental health history) and older age. High risk medications (e.g. anticoagulants, insulin, antibiotics, immunosuppressants and Parkinson's medications), and laboratory test results (non-therapeutic INR, potassium and sodium levels, and rising creatinine levels) were also identified as key criteria. Organisational demands, such as time of discharge and supply of medications were other factors that influenced patient priority. Pharmacists frequently commented on prioritisation being challenging and time consuming.

**Discussion:** Clinical pharmacists identified patient prioritisation as a complex multifactorial process that is important in the quality versus quantity battle. The identification of key criteria will help inform the development of a predictive risk score to facilitate an efficient and systematic approach to patient prioritisation that enables the best use of clinical pharmacist resources and optimises patient outcomes.

Lazarou J et al (1998) JAMA 279 15:1200-1205

**234 Evaluation of a quantitative approach for analysis of semi-structured pharmacy consumer interviews**

Ardalan Mirzaei<sup>1</sup>, Claudia Rittsteuer<sup>2</sup> Stephen R Carter<sup>1</sup>, Carl R Schneider<sup>1</sup>, <sup>1</sup>Faculty of Pharmacy, The University of Sydney, Sydney, NSW, Australia, <sup>2</sup>Karolinska Institutet, Stockholm, Sweden

**Introduction:** Thematic analysis of interview data can be laborious and time consuming. Contemporary software and computers have the processing speed and capacity to identify relationships amongst text transcripts. Yet, it is uncertain if they have the same capacity as humans to derive deeper meaning. One such mathematical approach to determine the deeper meaning of text is to see how words cluster and whether clustering can inform thematic analysis. Further, the sentiment of text can also be calculated.

**Aims:** To determine the information quantitative analysis can extract from qualitative transcription data from community pharmacy consumers' perceptions of service quality.

**Methods:** The transcripts from 26 semi-structured interviews were subject to cluster analysis and sentiment analysis. The combined interviews, were processed using the statistical software program "R". Using multiple packages, and website resources, the data was first cleaned for; repetition of unhelpful words (such as "speaker 1"), punctuation, numeric characters, and English stop words. A term document matrix was then created before subjecting the data to cluster analysis and sentiment analysis. Previous thematic analysis performed on the transcripts was used to ascertain the validity of the results.

**Results:** The 4 different packages utilised for cluster analysis suggested between 2 to 20 clusters of words existing, as opposed to 27 themes identified by traditional thematic analysis. Sentiment analysis suggested that the conversations were predominately favourably disposed.

**Discussion:** Quantitatively analysing text can provide quick insight and helpful graphics. However, the human skill of qualitative interpretation provided greater definition in development of themes as determined via cluster analysis. However, associations between clusters can indicate relationships between themes which may be a useful contribution to future psychometric testing. Furthermore, the sentiment analysis of text highlights a quantitative approach to calculate emotion in conversation. However, sentiment analysis does not take into account paraverbal information such as tone.

**235 Response of Community pharmacy staff to a request for an antibiotic product without a valid prescription: A simulated client study in Sri Lanka**

Shukry Zawahir<sup>1</sup>, Sarath Lekamwasam<sup>2</sup> and Parisa Aslani<sup>1</sup>, <sup>1</sup>Faculty of Pharmacy, the University of Sydney, Sydney, NSW, Australia, <sup>2</sup>Population Health Research Centre, Faculty of Medicine, the University of Ruhuna, Galle, Sri Lanka

**Introduction:** Dispensing antibiotics without a prescription was forbidden by Sri Lankan law in 1989 in order to prevent misuse of antibiotics. The effect of this policy change has not been evaluated yet.

**Objectives:** To evaluate the response of community pharmacy staff to an antibiotic product request without a prescription and to explore possible factors influencing such practice.

**Methods:** A cross-sectional study was conducted from Jan-June 2017. A total of 232 (response rate, 92%) community pharmacies from all 9 provinces in Sri Lanka consented to participate, and were visited by trained simulated clients (SCs) who requested one specific antibiotic (erythromycin tabs, or amoxicillin syrup, or metronidazole tabs by name; or ciprofloxacin tabs by showing an empty strip). Data on the interaction (availability of pharmacists, antibiotic dispensed and recommendations provided) were recorded immediately after each visit using a data collection sheet.

**Results:** Of the 232 pharmacies visited, 108 (47%) had a qualified pharmacist present during the visit. Pharmacy staff asked for a prescription for the requested antibiotic in 106/232 (46%) of the SC visits. Only 16/232 (7%) pharmacies correctly referred the SC to a doctor, but 5 of them still dispensed the antibiotic. Overall, 144/232 (62%) pharmacies dispensed antibiotics without a prescription, and 88/232 did not. Of the 88, 7 (8%) were out of stock at that time. The highest dispensed antibiotic was ciprofloxacin 41/54 (76%) followed by metronidazole 38/57 (67%), erythromycin 33/59 (56%) and amoxicillin 32/62 (52%). The availability of a pharmacist reduced the risk of dispensing antibiotics without a prescription (Adj. OR=0.49, 95% CI: 0.28-0.86;  $P=0.013$ ); whilst requesting an antibiotic by showing an empty strip (ciprofloxacin) vs requesting by name increased the risk of prescribing an antibiotic without a prescription (OR=2.44, 95% CI: 1.11-5.58;  $P=0.027$ ).

**Conclusion:** In Sri Lanka, a large proportion of community pharmacies dispensed antibiotics without a prescription despite the law prohibiting such practice. Making a professionally qualified pharmacist available at all times, strong enforcement of existing laws, and implementation of guidelines on antibiotic dispensing may change the antibiotic dispensing practice among community pharmacies in Sri Lanka.

**236 What Is Polypharmacy Exactly (WIPE)**

Nashwa Masnoon<sup>1,2</sup>, Sepehr Shakib<sup>3,4</sup>, Lisa Kalisch-Ellett<sup>1</sup>, Gillian Caughey<sup>1,3,4</sup>, <sup>1</sup>School of Pharmacy and Medical Sciences, Univ of South Australia, Adelaide, SA, <sup>2</sup>Dept of Pharmacy, Royal Adelaide Hosp, Adelaide, SA, <sup>3</sup>Dept of Clinical Pharmacol, Royal Adelaide Hosp, Adelaide, SA, <sup>4</sup>Dept of Clinical Pharmacol, Univ of Adelaide, Adelaide, SA

**Introduction:** There are various definitions of polypharmacy and it is unclear how different clinicians define and assess polypharmacy in practice, which can provide important insight into medication review and rationalisation.

**Aims:** To develop a website which allows evaluation of different clinicians' assessment of polypharmacy and identification of medication related factors which are considered during medication review and rationalisation.

**Methods:** A website called What Is Polypharmacy Exactly (WIPE) was developed which presents de-identified patient cases from clinical practice at [wipe.logicsquad.net/signup](http://wipe.logicsquad.net/signup). For each case, the website presents the patient's age and setting, list of comorbidities and medications and asks users to i. rate the degree of polypharmacy ii. rate the potential for harm from medications iii. rate the potential to deprescribe medications and iv. nominate medication classes for deprescribing. WIPE provides users with feedback by expert clinicians after case completion as well as the ability to post comments and engage in clinical discussion regarding each case with other users on the website.

**Results:** There have been 212 responses on WIPE from 61 users comprising of hospital and community pharmacists, consultant physicians, resident medical officers and medical students. Initial data analysis shows that medication classes such as benzodiazepines, opioids, sedating antihistamines and antipsychotics obtained higher ratings regarding the degree of polypharmacy and the potential for harm compared to statins, inhaled medications and paracetamol. Clinicians were more likely to nominate the medication classes which were associated with higher degree of polypharmacy and potential to cause harm for deprescribing.

**Discussion:** Clinician ratings reflect important aspects of medication review and rationalisation where medications which are identified as having the potential to cause harm are assessed for the possibility of deprescribing in order to optimise patient outcomes. WIPE can be used as an educational tool and allows a novel platform for users at the national and international level to work together to collectively define polypharmacy, in order to develop clear prescribing guidelines and improve patient outcomes.

**237 Psychotropic medicines use in Residents And Culture: Influencing Clinical Excellence (PRACTICE) tool: A development and content validation study**

Mouna Sawan<sup>1</sup>, Yun-Hee Jeon<sup>2</sup>, Timothy F Chen<sup>1</sup>, <sup>1</sup>Faculty of Pharmacy, University of Sydney, Camperdown, NSW, <sup>2</sup>Faculty of Nursing, University of Sydney, Camperdown, NSW

**Introduction:** Organizational culture has been identified to be a key factor that contributes to the high-level prescribing and significant variation in the use of psychotropic medicines across aged care homes. There are gaps in existing tools used to link organizational culture to the use of psychotropic medicines.

**Aims:** The aim of this research was to develop and content validate a tool that measures organizational culture concerning the use of psychotropic medicines in aged care homes, named the Psychotropic medicines use in Residents And Culture Influencing Clinical Excellence (PRACTICE) tool.

**Methods:** The tool was developed based on a comprehensive systematic review, qualitative research and generated by the research team. Content validity was assessed using the CVI (Content Validity Index). The content relevance and importance of the PRACTICE tool items were rated by an expert panel with relevant knowledge and experience. Any modified or re-worded items were presented to the panel members in a subsequent round for re-rating.

**Results:** The PRACTICE tool had 68 items that assessed all aspects of culture. Sixty-two items out of 68 (91%) met predefined cut-off values ( $\geq 0.78$ ) for the item level CVI. The remaining six items (9%) did not fully meet the cut-off values, but based on the systematic review and qualitative research it deemed important to be included in the tool.

**Discussion:** The PRACTICE tool is a step forward in validating an instrument that will help inform managers and policy makers to identify target areas for improvement to create a culture of appropriate psychotropic prescribing in aged care homes.

**238 “Good prescribing is a bit like good driving; everybody thinks they’re a good driver.” An exploratory study on the barriers and facilitators to using quality prescribing indicators (QPIs) in general practice**

Li Shean Toh, Angus Thompson, Anuj Shah, Justin Cousins, Shane Jackson, Nick Cooling, Gregory Peterson, School of Medicine, University of Tasmania<sup>1</sup>, Hobart, TAS, Australia

**Introduction:** Medication-related problems (MRPs) are an important source of patient morbidity in Australia. Quality prescribing indicators (QPIs) have been developed to prevent and reduce MRPs. In Australia, a set of QPIs for general practice was published in 2006 by NPS MedicineWise, but these have not been updated or widely used.

**Aims:** To explore the perceived barriers and facilitators to using QPIs in general practice.

**Methods:** Focus group discussions (FGDs) were conducted with general practitioners (GPs) using a semi-structure topic guide (n=4, each group had 2-6 GPs and one had a GP-based pharmacist). Participants were purposively sampled based on their experience and practice location. Interviews were transcribed verbatim and thematically analysed. Arising themes were then categorised according to an adapted Reason’s model from the protocol for the investigation and analysis of clinical incidents.

**Results:** Six main categories of barriers to using QPIs were identified: governmental, organisational and management, work environment, task, individual and patient. GPs perceived that there is currently no government funding targeted at quality prescribing activities, leading to prioritization of other activities. The fragmented healthcare system contributed to a lack of standardisation in medical records systems resulting in inconsistent data extraction and sharing. GPs cited time and staffing constraints in the work environment. Having a GP-based pharmacist was seen as a facilitator to using QPIs. The task and technology barrier highlighted that QPIs were seen to be targeting areas that were not useful or out of context to practice, were difficult to interpret or outdated. GPs cited alert fatigue with their prescribing software and concerns that conspicuous alerts created unnecessary anxiety for patients. At an individual level, GPs had a lack of awareness and were reluctant to engage with the QPIs. Time pressure to see patients, increasing patient complexity and medication adherence were also barriers. Nonetheless, GPs perceived QPIs to be potentially useful, similarly to NPS MedicineWise audit reports, and the GPs had a willingness to improve practice.

**Discussion:** The implementation of QPIs in general practice faced barriers at various levels. A multi-level intervention approach is required for their implementation to be successful.

**239 Contextualised medication information is critical to treatment uptake and adherence among people living with HIV**

Amary Mey<sup>1</sup>, Shai Dukie<sup>1</sup>, Gary Rogers<sup>2</sup>, Maree O’Sullivan<sup>3</sup>, David Plummer<sup>4</sup>, <sup>1</sup>School of Pharmacy & Pharmacology, Griffith University, Gold Coast, QLD, Australia, <sup>2</sup>School of Medicine, Griffith University, Gold Coast, QLD, Australia, <sup>3</sup>Sexual Health Service<sup>3</sup>, Gold Coast, <sup>4</sup>College of Public Health, Medical & Veterinary Sciences, James Cook University, Townsville, QLD, Australia

**Introduction:** Despite the well-established life-preserving benefits of anti-retroviral therapy (ART), some people living with HIV choose to decline, delay or diverge from prescribed regimens<sup>(1)</sup>. Understanding how treatment decisions are made may facilitate the development of strategies to overcome barriers to treatment uptake and adherence.

**Aim:** To explore beliefs of people living with HIV about treatment.

**Methods:** In-depth interviews were conducted with adults living in or around the Gold Coast region of Australia between March 2016 and July 2017. Interviews were audio recorded, transcribed verbatim and analysed using grounded theory framework. Ethical approval HREC / 15 / QGC / 256.

**Results:** Forty adults who had been living with HIV for between one month and 39 years were interviewed. The majority identified information as a key unmet need. Fears about side effects, association of medication taking with loss of previous uninfected identity, and negative views towards pharmaceuticals, were reasons for rejecting or delaying treatment with treatment fatigue, planning for pregnancy and going on holiday as reasons for deliberate non-adherence. Fear of death, wanting to protect others, ongoing support and receipt of contextualised medication information were strong motivators for treatment uptake and adherence.

**Discussion:** Contextualised information and ongoing support are crucial to treatment decisions for this vulnerable population group. These findings suggest a potential for pharmacists to be involved in caring for people living with HIV beyond the current confines of their practice locations.

1. Mey A, Plummer D, Dukie S, Rogers GD, O’Sullivan M, Domberelli A. Motivations and Barriers to Treatment Uptake and Adherence Among People Living with HIV in Australia: A Mixed-Methods Systematic Review. *AIDS and behavior*. 2017;21(2):352-85.

**240 A study on usual Residential Medication Management Review (RMMR) practice**

Leila Shafiee Hanjani<sup>1</sup>, Christopher R Freeman<sup>2</sup>, Nancye M Peel<sup>1</sup>, Liam J. Caffery<sup>3</sup>, Len C. Gray<sup>1</sup>, <sup>1</sup>CRGM, UQ, Brisbane, QLD; PACE, UQ<sup>2</sup>, Brisbane, QLD; COH, PAH<sup>3</sup>, Brisbane, QLD

**Introduction:** RMMR is available to residents of Residential Aged Care Facilities (RACFs) and aims to identify, resolve and prevent medication-related problems. Ideally, RMMRs should be conducted and reported to RACFs in a timely fashion.

**Aims:** To describe current practice model for RMMRs and areas for potential enhancement of the model.

**Methods:** A questionnaire on usual practice of conducting RMMRs, seeking information on distance pharmacists travelled to and from the facility, time taken to complete the review including travel, locating and reviewing required information and reporting, contact with residents and staff, number of reviews conducted in the visit and issues or barriers encountered, was developed and piloted. Five experienced RMMR accredited pharmacists were asked to complete the questionnaire in their 5 consecutive visits to 5 different RACFs.

**Results:** Pharmacists completed the questionnaire in 24 visits to 24 RACFs. They conducted an average of 10 RMMRs per visit and the median distance they travelled to do these was 61 kilometres (km) with a range of 10 to 1774 km. Median time spent for each review, including time for travel, locating and reviewing required information and report writing, was 63 min. Nurses were consulted frequently (83% of visits) and patients were only consulted in 17% of the visits. In 33% of the visits they encountered an issue or barrier affecting their capacity to conduct RMMRs such as nurses not being available or computer and login issues. On most occasions (17/24), the reports were made available to the facility 48 hours or more after the visit.

**Discussion:** Although the median distance pharmacists travelled to conduct RMMRs was less than the results of the Government report on evaluation of RMMR service in 2010, the range in distance travelled was immense. Travel time and distance can both act as barriers to performing timely and efficient medication reviews. Conducting timely reviews can be further affected by late availability of the reports to the facilities which occurred on majority of visits in our study. Alternative ways to conduct RMMRs, such as telehealth-enabled medication reviews, may provide a mechanism to overcome these issues which is of particular importance to regional, rural and remote settings where access to these services is generally poor.

**241 IRAK3 modulates NFκB through its guanylate cyclase activity**

Lubna A. Freihat, David T. Manallack, Janet I. Wheeler, Helen R. Irving. Drug Discovery Biology, Monash Institute of Pharmaceutical Sciences - Monash University, 381 Royal Parade, Parkville, VIC 3052, Australia.

**Introduction.** Interleukin-1 receptor associated kinase 3 (IRAK3) acts as a negative regulator of inflammation. The role of IRAK3 is critical to maintaining homeostasis in the innate immune response and in preventing the development of autoimmune diseases. It is involved in various inflammation-associated disorders such as lung injury, metabolic syndrome and tumour growth. Prior studies identified IRAK3 as a potential novel guanylate cyclase (GC) catalyzing cyclic guanosine monophosphate (cGMP) synthesis. IRAK3 is predicted to be a mammalian representative of a new class of GCs containing a GC centre encapsulated within the kinase domain. (Freihat et al., 2014).

**Aims.** To investigate if IRAK3 is capable of generating cGMP and if modifying the GC centre modulates the downstream signaling pathways.

**Methods.** GC activity was assessed using the GE Amersham cGMP enzyme immunoassay kit. HEK BLUE hTLR4 cells containing a SEAP reporter system were transfected with either IRAK3 or IRAK3 mutant constructs, effects on NFκB activity in the presence of lipopolysaccharide (LPS) and cGMP were investigated.

**Results.** Recombinant IRAK3 protein produced significant amounts of cGMP in vitro, whilst the IRAK3 GC mutant did not. Overexpression of IRAK3 in HEK BLUE hTLR4 cells significantly reduced LPS induced, NFκB activation. Whereas IRAK3 GC mutants with reduced cGMP-generating capacity failed to inhibit LPS induced NFκB activity. The presence of cell-permeable cGMP restored IRAK3 function and significantly reduced NFκB activity in IRAK3 mutants with reduced cGMP-generating capacity.

**Discussion.** Low levels of cGMP are important for IRAK3 action and these findings are providing insight into the hidden functions of IRAK3 and may assist in explaining its selectivity and functionality in the inflammatory signalling cascade. Understanding how this novel GC function impacts the anti-inflammatory effect of IRAK3 is likely to be important when targeting this protein in different disease states.

Freihat, L., Muleya, V., Manallack, D.T., Wheeler, J.I., and Irving, H.R. (2014). *Biochemical Society Transactions* 42, 1773-1779.

**242 Intranasal delivery of the TLR7 agonist, imiquimod, protects against influenza A virus-induced morbidity in mice**

Jonathan R. Erlich<sup>1</sup>, Eunice E. To<sup>1,2</sup>, Raymond Luong<sup>1,2</sup>, Felicia Liong<sup>1</sup>, Keshia Hendricks<sup>2</sup>, Steven Bozinovski<sup>1</sup>, John J. O'Leary<sup>3</sup>, Doug A. Brooks<sup>4</sup>, Ross Vlahos<sup>1</sup>, Stavros Selemidis<sup>1,2</sup>. <sup>1</sup>School of Health and Biomedical Sciences, RMIT University Bundoora, VIC, Australia; <sup>2</sup>Dept of Pharmacology, Monash University, Clayton, VIC, Australia. <sup>3</sup>School of Medicine, Trinity Translational Medicine Institute, Trinity College Dublin, Ireland. <sup>4</sup>School of Pharmacy and Medical Sciences, Sansom Institute for Health Research, University of South Australia, Adelaide, Australia.

**Introduction.** Influenza is a significant global burden with 5 million cases per year, 10% of which are fatal and thus, there is an urgent need for new therapeutics (WHO factsheet, 2017). Toll like receptor 7 (TLR7) is a pattern recognition receptor, which drives a powerful anti-viral signalling pathway that helps clear virus infections.

**Aim.** To determine the effect of the TLR7 agonist imiquimod on lung inflammation, oxidative stress and antibody production caused by influenza A virus (IAV) infection in mice.

**Methods.** Saline or imiquimod (50µg/mouse) was delivered intranasally to anaesthetised (inhaled isoflurane; 3%) male C57BL/6J mice one day prior to infection with a low (10<sup>3</sup>PFU/mouse), moderate (10<sup>4</sup>PFU/mouse) or high dose (10<sup>5</sup>PFU/mouse) of the mouse adapted Hong Kong X31 (x-31) virus strain and everyday thereafter until mice were culled day 3 (d3) or 7 (d7) post-infection for analysis. Bronchoalveolar lavage (BAL) was performed to assess airways inflammation, and oxidative burst by L-012 enhanced chemiluminescence. In addition, BAL fluid and serum was used to determine antibody titres. The lungs were harvested and used to assess inflammation (H&E staining) and pro-inflammatory cytokine gene expression by qPCR. Bodyweights were recorded daily during the experimental process.

**Results.** Imiquimod significantly suppressed body weight loss caused by IAV infection with a maximum reduction of ~60% starting from day 4 (10<sup>3</sup> PFU/mouse, n=7-13, p<0.001). At d3 post infection, imiquimod treatment caused a significant reduction (~50-60%) in airway and peri-bronchial inflammation and BALF neutrophil populations (10<sup>5</sup> PFU/mouse, n=8-15, p<0.01) but had no effect on macrophage and lymphocyte populations, and the oxidative burst. TNF-α and IL-6 mRNA expression was suppressed by ~60% (p<0.01 and p<0.05, respectively). Day 7 showed a modest but significant increase in IgE, IgM, IgG1, and IgG2a (p<0.05) in BALF following imiquimod treatment.

**Discussion.** Our findings highlight an exciting potential of imiquimod as a therapeutic option for the treatment of influenza disease.

**243 A novel endosomal NOX2 oxidase inhibitor protects against high pathogenicity influenza A virus-induced disease**

Eunice E. To<sup>1,2</sup>, Raymond Luong<sup>1</sup>, Felicia Liong<sup>1</sup>, Jiayin Diao<sup>3</sup>, Steven Bozinovski<sup>1</sup>, Christopher J.H. Porter<sup>3</sup>, Tim Quach<sup>3</sup>, John O'Leary<sup>4</sup>, Doug A. Brooks<sup>5</sup>, Ross Vlahos<sup>1</sup>, Stavros Selemidis<sup>1,2</sup>. <sup>1</sup>School of Health and Biomedical Sciences, RMIT University, Bundoora, VIC, Australia, <sup>2</sup>Dept of Pharmacology, Monash University, Clayton, VIC, Australia, <sup>3</sup>Monash Institute of Pharmaceutical Sciences, Monash University, Parkville, VIC, Australia, <sup>4</sup>School of Medicine, Trinity Translational Medicine Institute, Trinity College Dublin, Ireland, <sup>5</sup>School of Pharmacy and Medical Sciences, Sansom Institute for Health Research, University of South Australia<sup>5</sup>, Adelaide, Australia

**Introduction:** We have shown that influenza A viruses, *irrespective* of strain, cause a burst of reactive oxygen species (ROS) production via NOX2 oxidase that occurs in endosomes (To et al, 2017). We also showed that an endosome targeted NOX2 oxidase inhibitor called cholestenol conjugated gp91ds-TAT (Cgp91) was significantly more effective at inhibiting NOX2 oxidase than an unconjugated version of the same drug. Strikingly targeted inhibition of endosomal ROS production with Cgp91 abrogated disease caused by a seasonal strain of influenza A virus (IAV) in mice.

**Aim:** Determine the effect of Cgp91 treatment on the lung pathology induced by a highly pathogenic strain of IAV.

**Methods:** Male C57Bl/6J mice were treated daily *via* intranasal administration with Cgp91 (0.2mg/kg) or DMSO (2%; control) over a 4-day period. Mice were infected with the PR8 (H1N1; 500 PFUs) strain of IAV or PBS control, one-day post initial drug treatment and analysed at day 3 (d3) post infection. Bronchoalveolar lavage (BAL) fluid collected from mice was used to assess airway inflammation. Histopathological analysis of lung was assessed using H&E stain and scored for alveolitis, inflammatory cell infiltrate and peribronchiolar inflammation. Superoxide generation in the BAL was measured using L-012 enhanced chemiluminescence and changes in cytokine and viral mRNA expression in the lung were quantified using real-time QPCR.

**Results:** Cgp91 treatment significantly (P<0.05) reduced airway inflammation, neutrophil influx, and pulmonary inflammation as measured by the degree of alveolitis, inflammatory cell infiltrate and peribronchiolar inflammation. Additionally, Cgp91 attenuated ROS generation and influenza viral mRNA expression in PR8-infected mice.

**Discussion:** The spatial inhibition of NOX2 in endosomal compartments with Cgp91 could be used as a potential treatment strategy for highly pathogenic influenza A virus infections.

To *et al.* Nature Communications, **8**, Article number: 69(2017).

**244 Localisation of polymyxin in human alveolar epithelial cells**

Maizbha U Ahmed<sup>1,2</sup>, Mohammad AK Azad<sup>2</sup>, Alex Fulcher<sup>3</sup>, Tony Zhou<sup>4</sup>, Fanfan Zhou<sup>5</sup>, Kim Chan<sup>5</sup>, Tony Velkov<sup>1</sup>, Jian Li<sup>2</sup>  
<sup>1</sup>Monash Institute of Pharmaceutical sciences, Monash University, Parkville, VIC, Australia, <sup>2</sup>Department of Microbiology, Monash University, Clayton, VIC, Australia, <sup>3</sup>Monash Micro Imaging, Monash University, Clayton, VIC, Australia, <sup>4</sup>Department of Industrial and Physical Pharmacy, College of Pharmacy, Purdue University, West Lafayette, IN, USA; Faculty of Pharmacy, The University of Sydney<sup>5</sup>, Camperdown, NSW, Australia

**Introduction:** Inhaled polymyxin therapy is currently empirical and often the large doses administered could lead to potential pulmonary adverse effects. We demonstrated the involvement of both the death receptor and mitochondrial apoptotic pathways in polymyxin-induced pulmonary toxicity. Presently, there remains a dearth of information on the detail mechanisms of polymyxin induced lung toxicity and the intracellular localisation of polymyxins in lung epithelial cells.

**Aims:** This study aimed to investigate the intracellular localisation of polymyxin B (PMB) in A549 lung epithelial cells.

**Methods:** A549 cells were subject to PMB treatments (0.1, 0.5, and 1.0 mM for 1, 4 and 24 h), and various organelles along with ubiquitin and PMB were visualised by immunostaining. Cells were imaged using confocal microscopy.

**Results:** PMB co-localised with early endosomes across all time points. Significant co-localisation of PMB with mitochondria was observed that led to the alteration of mitochondrial morphology from filamentous to fragmented ( $n=3$ ,  $p < 0.001$ ). PMB also co-localised with lysosomes and ubiquitin. Significant increases in the autophagic protein LC3A were observed at higher concentrations (0.5 mM and 1.0 mM) of PMB.

**Discussion:** The subcellular imaging of A549 cells reveals that PMB significantly co-localised with mitochondria and caused severe mitochondrial damage which may account for the polymyxin-induced activation of mitochondrial apoptosis pathway we previously observed in A549 cells. The formation of autophagosomes and lysosomes is likely a cellular response to the drug-induced stress and plays a defensive role by disassembling dysfunctional organelles and proteins. Our study provides fundamental knowledge for understanding the mechanisms of polymyxin-induced lung toxicity, which would be vital for optimising their use in the clinic.

Ahmed MU *et al* (2017) *Antimicrob Agents Chemother* 61(6): e02690-16

**245 Pharmacological characterisation of small molecule C5aR1 inhibitors in primary human macrophages**

Xaria X. Li, Daniel E. Croker, Richard J. Clark Trent M. Woodruff, School of Biomedical Sciences, The University of Queensland, Brisbane, QLD, Australia

**Introduction:** The complement system is an essential component of innate immunity. The complement factor C5a is a core effector protein that exerts potent proinflammatory and immunomodulatory functions through its major receptor C5aR1. Over-activation of the C5a-C5aR1 axis has been implicated in a plethora of acute and chronic diseases, propelling the development of therapeutic inhibitors of C5aR1. Despite a number of these inhibitors being developed, to date, no systematic pharmacological characterisation of these compounds has been reported in human immune cells.

**Aims:** To compare the antagonistic potency and duration of inhibition of selected C5aR1 inhibitors against C5a-mediated cytokine release and phospho-ERK1/2 signalling respectively in primary human macrophages *in vitro*.

**Methods:** The peptidic (PMX53, PMX205, JPE1375) and non-peptide (W54011, NDT9513727) C5aR1 inhibitors were profiled in human monocyte-derived macrophages (HMDMs). IL-6 and IL-10 release in the co-presence of LPS was quantified using ELISA. Time-lapse pERK1/2 activity was examined using a AlphaLISA-based kit.

**Results:** The peptidic compounds were significantly more potent than the non-peptide small molecules in inhibiting the immunomodulatory effect of C5a. The rank order of potency was JPE1375 > PMX53 > PMX205 > NDT9513727 > W54011 for both IL-6 and IL-10 assays. In the wash-off study for pERK1/2 activity, PMX53 and JPE1375 possessed significantly longer duration of antagonistic activity ( $t_{1/2} > 24$  h) compared to the remaining inhibitors ( $t_{1/2} \sim 5$  h).

**Discussion:** The peptidic C5aR1 inhibitors are more effective at inhibiting C5aR1-mediated immunomodulatory effects in primary human immune cells, possibly due to their prolonged duration of receptor antagonism. The peptidic inhibitors may thus represent more ideal clinical drug candidates due to their potent and prolonged antagonistic activities.

**246 Getting under the skin – Why receptor fluid choice is crucial in in vitro skin permeation tests**

Ana Macedo<sup>1,2</sup>, Azadeh Aliganhi<sup>1,2</sup>, Amy Holmes<sup>1,2</sup>, Michael Roberts<sup>1,2,3</sup>. Therapeutics Research Centre<sup>1</sup>, School of Pharmacy and Medical Sciences, University of South Australia, Adelaide, SA, Australia; Therapeutics Research Centre<sup>2</sup>, The Basil Hetzel Institute for Translational Health Research, Adelaide, SA, Australia; Therapeutics Research Centre<sup>3</sup>, School of Medicine, The University of Queensland, Brisbane, QLD, Australia

**Introduction.** *In vitro* human skin permeation tests (IVPT) are used as an alternative to *in vivo* studies in assessing skin penetration of drugs, pesticides, and cosmetics. The Organisation for Economic Co-operation and Development (OECD) guidelines advise that a physiologically relevant receptor solution should be selected (e.g. phosphate buffer saline, PBS pH 7.4) for permeation studies. However, this has not been validated for key solutes.

**Aims.** To examine the effect of receptor composition on the IVPT using a homologous series of aliphatic alcohols.

**Methods** Experimental solubility and human epidermal IVPT data were generated for a series of <sup>14</sup>C alcohols (ethanol, propanol, pentanol, heptanol, octanol, and decanol) using OECD recommended receptor solutions in side-by-side diffusion cells at 25°C±1°C. Transient and steady-state epidermal fluxes, as well as permeability coefficients, were estimated without and with adjustment for possible non-sink receptor conditions.

**Results.** Higher permeability coefficients were observed with the longer carbon chain alcohols and these permeability coefficients depended on the solubility of the alcohol in the receptor phase. The permeation fluxes of alcohols in this study were dependent on the receptor phase composition for the more lipophilic solutes, as depicted for decanol in the figure.

**Discussion.** The selection of the IVPT receptor phase is crucial for poorly water soluble solutes.

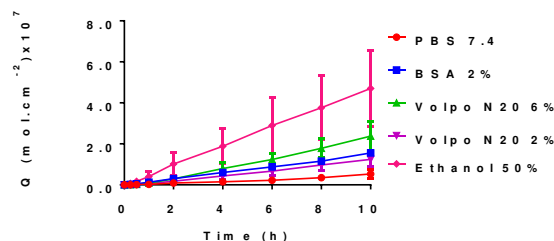

**247 Can an educational intervention lead to a sustained reduction in gastric lavage for poisoning admissions?**

J Raubenheimer<sup>1</sup>; A Dawson<sup>1</sup>; L Senarathna<sup>2</sup>, S Jayamanne<sup>3</sup>, P L Ariyanadana<sup>4</sup>, I Gawarramana<sup>5</sup> and N Buckley<sup>1</sup>, <sup>1</sup>University of Sydney, NSW, Australia, <sup>2</sup>Rajarata University, Sri Lanka, <sup>3</sup>University of Kelaniya, Sri Lanka, <sup>4</sup>University of Ruhuna, Sri Lanka, <sup>5</sup>University of Peradeniya, Sri Lanka

**Introduction:** A clustered RCT of educational interventions on treatment of patients with acute poisoning in rural Asian hospitals collected data on all acute poisonings for the period October 2010 to December 2014 in four provinces of Sri Lanka, providing 20 759 cases in total.

**Aims:** One of the major aims of the study was to effect a reduction in forced emesis and/or gastric lavage for poisoning admissions in primary hospitals, together with an increase in the use of activated charcoal, where applicable.

**Methods:** Primary hospitals from four Sri Lankan regions were randomised (1:1:1) between three study arms. The first obtained a set of poisoning treatment guidelines only (considered the placebo arm). The second (intervention 1) received a half-day interactive teaching session using a lecture/workshop format delivered by an expert (consultant physician) in the primary hospital to medical and other hospital staff. The third (intervention 2) received a “train-the-trainer” intervention where a full day educational session was provided to available primary care doctors and nursing staff from a number of health institutions in a central location, where they were equipped, and provided with materials, for repeating the training at their institutions. The interventions were rolled out between February and December 2011. All poisoning admissions were recorded for a period of two years, with a complete history of treatment and outcomes.

**Results:** For the expert presentation group, an immediate increase in the use of activated charcoal was seen, which was sustained throughout the study period. Gastric lavage did not decrease immediately, but did subside in the long term. The train-the-trainer arm showed very little change over the study period, while the guideline grouped showed increases in both the use of activated charcoal and gastric lavage.

**Discussion:** It appears that the intervention was moderately successful when the training was done by an expert on site, although the full impact took time to develop. Even the train-the-trainer intervention seemed to be able to prevent a worsening of the situation, while the guidelines appeared to have no effect.

**248 Optimising medicines for optimal patient outcomes? Perhaps we need more comparative ineffectiveness research!**

Nicholas A Buckley, Sydney Medical School, The University of Sydney, NSW, Australia

Many terms around drug regulation and policy have an Orwellian turn of phrase. The FDA Office of Drug Safety is tasked with monitoring drug toxicity. Pharmacovigilance largely refers to a passive process of waiting for someone else to notify adverse drug effects. Comparative effectiveness research seems to largely be applied to identify treatments that are less effective or more harmful, generally or in specific populations or settings.

My research over the years has identified many drugs that are more toxic, more misused, less appropriate, cause more adverse reactions, more drug interactions, and/or reduced adherence; sadly, it has yet to identify any single drugs that stand out from the pack due to superior characteristics. This may be a reflection of where all new truths about marketed drugs are most likely to be found. Alternatively, it might just reflect the typical focus of an academic research career in pharmaco-epidemiology, clinical pharmacology & toxicology.

My early research focussed on using clinical databases on poisoned patients and coronial data to identify drugs with higher toxicity relative to other agents used for the same indications. For example, dothiepin, desipramine, thioridazine, short acting barbiturates, chloral hydrate, pheniramine, propranolol, temazepam gel caps, venlafaxine were all singled out as being more toxic in overdose and/or having more fatal poisonings per prescription than alternative substitute treatments. This led to various changes in regulations, scheduling, product information and treatment guidelines, but typically these were decades or more after the drugs first came to market.

More recently, it is apparent that linked routinely collected health data, the National Coronial database and Poisons Centre identified cohorts have the potential to identify such problems much more efficiently and rapidly, and determine if regulatory interventions are effective. Modified release paracetamol, DMAA, alprazolam, codeine, oxycodone, Targin, fentanyl, quetiapine, pregabalin, are examples of drugs where emerging issues are being identified and a much more rapid targeted response with subsequent evaluation is possible. ASCEPT members are enthusiastic about sowing the seeds to work the field of therapeutics. But somebody also needs to weed the garden.

**300 Colloids, carriers and collaborations: A pathway to enhanced drug delivery**

Christopher J.H. Porter<sup>1,2</sup>, <sup>1</sup>Monash Institute of Pharmaceutical Sciences and <sup>2</sup>ARC Centre of Excellence in Convergent Bio-Nano Science and Technology, Monash University, Parkville, Vic, Australia

In an era of increasingly complex drug targets, drug delivery science remains an essential component of the drug development continuum. Great strides have occurred in drug discovery through an understanding of complex biology and disease progression pathways, however next generation medicines present greater and greater challenges for effective delivery.

Over the last several years my lab has been exploring ways in which 'problem' drugs may be better delivered – be they anticancer therapies with low activity and high toxicity, poorly soluble drugs with limited oral bioavailability or immunomodulators where traditional delivery modalities fail to promote access to lymphocyte resident targets. A common theme across the approaches we have taken has been to better understand endogenous transport pathways and to harness (rather than fight) these mechanisms for drug delivery. In this presentation I will describe our efforts to utilise lipid-based formulations to promote drug solubilisation in the gastrointestinal tract, and to develop novel models to better understand drug absorption from intestinal colloidal species. I will outline the most recent results from a long term collaboration to enhance tumour specific drug delivery using dendrimer-based nanomedicines, and finally I will highlight a program of work to harness an alternate transport pathway, the lymphatic system, to enhance bioavailability and promote drug delivery to immune tissues and lymph nodes. Across all of these programs, a highlight has been the opportunity to collaborate with a wide range of world-class scientists, both locally and internationally, in industry and academia; these relationships have underpinned the work we have been able to do and the research areas we have been able to progress.

**301 The use of oral anticoagulants in people in dementia**

Jenni Ilomäki<sup>1,2</sup>. Centre for Medicine Use and Safety, Monash Univ<sup>1</sup>, Parkville, VIC, Department of Epidemiology and Preventive Medicine, Monash Univ<sup>2</sup>, Melbourne, VIC

**Introduction.** People with dementia may be less likely to be prescribed guideline recommended medicines for prevention of ischaemic stroke (IS) and other chronic conditions. It is unclear whether this disparity reflects 1) legitimate consideration of the lack of evidence and efficacy in people with dementia and concern about susceptibility to adverse drug events (ADEs), 2) recognition of peoples' changing goals of care, or 3) the unjustified exclusion of people with dementia from receipt of guideline recommended health care.

**Aims.** To describe pharmacoepidemiological research on medication use in people with dementia focusing on oral anticoagulant use.

**Methods.** An increasing range of data are available to investigate medication use in Australia and internationally. These data include electronic medical records from hospitals, prescribing data from primary care centres and pharmacy dispensing data. The 10% random sample of the Australian Pharmaceutical Benefits Scheme (PBS) provides opportunities to investigate the prevalence and uptake of oral anticoagulants in people with dementia from March 2005.

**Results.** Meta-analysis suggests the prevalence of oral anticoagulant use is lower in people with dementia than in people without dementia in all practice settings. In Australia, the overall prevalence of warfarin use in people with dementia increased from 3.6% in 2009 to 4.7% in 2016 while direct oral anticoagulant (DOAC) use increased from 0.04% to 7.0% over the same time period. International literature shows that people with dementia are more likely to experience ADEs related to oral anticoagulant use. INR control has been shown to be poorer in people with than without dementia.

**Discussion.** The prevalence of anticoagulant use in people with dementia has increased sharply in Australia since the introduction of DOACs. This may indicate more people with dementia receive appropriate treatment. However, there is a need for further research in the benefits and risks of DOAC use in people with dementia.

**302 Strategies for the precision use of targeted anti-cancer medicines**

Andrew Rowland<sup>1</sup>, Madelé van Dyk<sup>1</sup>, Michael J Sorich<sup>1</sup>, <sup>1</sup>Department of Clinical Pharmacology, College of Medicine and Public Health, Flinders University, Adelaide, SA, Australia

**Introduction:** The clinical implementation of a precision dosing strategy depends on three core elements: (1) the predictive performance and capacity to improve outcomes, (2) the ability to generate high quality evidence of clinical validity, and (3) the practicality of application. In Medical Oncology a major barrier to clinical translation of 'classical' precision dosing strategies such as therapeutic drug monitoring (TDM) is the preclusive cost and logistical complexity required to develop high quality prospective of validity.

**Aims:** To develop novel complementary strategies that facilitate the routine clinical translation of precision dosing for targeted anti-cancer medicines.

**Methods:** This program of research utilises a continuum of techniques spanning from physiological based-pharmacokinetic modelling (PBPK) and *in vitro* reaction phenotyping through to healthy volunteer and patient based clinical trials.

**Results:** Verified PBPK models identified an optimal set of covariates that define variability in exposure for a number of targeted anti-cancer medicines. By way of example, 94 % of the variability in steady-state dabrafenib exposure was defined by a model incorporating patient weight, and CYP3A4, CYP2C8 and P-gp protein abundances. In terms of defining protein abundances, an R<sup>2</sup> of 0.904 was attained for the correlation of circulating CYP3A4 protein expression in exosomes isolated from human plasma and midazolam apparent oral clearance (CL/F) in a cohort of 18 to 35 year old healthy Caucasian males of CYP3A4 \*1/\*1 (wild type) and CYP3A5 \*3/\*3 (non-functional) genotype pre- and post- rifampicin dosing (300mg QD for 7 days). Furthermore, the change in exosomal CYP3A4 expression defined 92% of the variability in the extent of CYP3A4 induction following treatment with rifampicin.

**Discussion:** Through the use of novel strategies to identify and quantify biomarkers defining drug exposure exposure, this program is demonstrating the capacity to derive clinically actionable insights from routinely collected samples from pivotal late phase RCTs regarding the pathways defining drug exposure in diagnostically amenable samples.

**303 Big data: Driving innovation for geriatric pharmacoepidemiology and pharmacovigilance research**

Dr Prasad Nishtala, University of Otago, New Zealand

A rapid increase in the quantity, diversity and accessibility of big electronic patient data has provided unprecedented opportunities for the assessment of drug safety in older people. Randomized controlled trials (RCTs) are considered the “gold standard” for producing evidence relating to the comparative risks and benefits of pharmaceuticals; however, RCTs have their own limitations. Importantly, they lack external validity and they often exclude older people with multiple comorbidities, and findings may not be generalisable to high-risk populations. Well-designed pharmacoepidemiological studies have been shown to correlate well with RCTs in terms of estimates of risk and effect size. My research will highlight some of the recent advancements in both pharmacoepidemiology and pharmacovigilance to understand medication safety in older people. In summary, my research addresses an important gap in international drug safety research, combining the power of a large population-based sample with innovative pharmacoepidemiology designs that can be used to identify frequent medication combinations associated with adverse drug events.

**304 Developing the next generation of analgesics**

Jennifer R Deuis, Inst for Molecular Bioscience, Univ of Queensland, St Lucia, QLD, Australia

Voltage-gated sodium ( $\text{Na}_v$ ) channels are integral membrane proteins that allow influx of sodium ions, essential for action potential generation and propagation in electrically excitable cells. Nine voltage-gated sodium channel subtypes have been described to date ( $\text{Na}_v1.1$ - $\text{Na}_v1.9$ ), several of which are implicated as causative contributors to pain. Of particular interest is  $\text{Na}_v1.7$ , as loss-of-function mutations cause congenital insensitivity to pain, a rare condition resulting in individuals who are otherwise normal except for the inability to sense pain. This has led to intensive efforts by the pharmaceutical industry to develop  $\text{Na}_v1.7$ -selective inhibitors as novel analgesics.  $\text{Na}_v1.7$  selectivity is key, as activity at other  $\text{Na}_v$  subtypes, including  $\text{Na}_v1.4$ , which is expressed in skeletal muscle,  $\text{Na}_v1.5$ , which is expressed in cardiac muscle, and  $\text{Na}_v1.6$ , which is expressed on motor neurons, is likely to cause dose-limiting adverse effects. We recently identified  $\mu$ -theraphotoxin-Pn3a, a novel peptide isolated from venom of the tarantula *Pamphobeteus nigricolor* that potently inhibits  $\text{Na}_v1.7$  ( $\text{IC}_{50}$  0.9 nM) with at least 40–1000-fold selectivity over all other  $\text{Na}_v$  subtypes, making it one of the most selective  $\text{Na}_v1.7$  inhibitors reported to date. Despite on-target activity, Pn3a alone displays no analgesic activity in multiple rodent models of acute inflammatory pain, including formalin-, carrageenan- or FCA-induced pain. However, when administered with a subtherapeutic dose of the opioid oxycodone, Pn3a exhibits profound analgesic activity. Thus, the combination of an opioid and a  $\text{Na}_v1.7$  selective inhibitor such as Pn3a is a promising new approach for the treatment of pain.

**305 BBB permeability of molecularly-targeted anti-tumor agents: Necessary for effective treatment of brain tumors**

Prof William Elmquist, University of Minnesota, USA

This talk will focus on the issues surrounding effective drug delivery to the invasive cells in brain tumors, both primary and metastatic. Many of the newer, molecularly-targeted anti-cancer agents have impressive inhibitory action against various signaling pathways that drive tumor growth. However, they have been ineffective in treating brain tumors. The mechanisms responsible for this failure must be explored before progress can be made, and inadequate drug delivery across an intact BBB may be one critical factor for invasive primary tumors, as well as the early micro-metastases from peripheral tumor sites. The molecularly-targeted signal transduction inhibitors are often substrates for active efflux transporters at the BBB, and this delivery-limiting mechanism must be overcome before these inhibitors can be adequately tested in clinical trials.

### 306 Clearance of beta-amyloid is facilitated by apolipoprotein E (apoE) and circulating high-density lipoproteins (HDL) in bioengineered human vessels

Jerome Robert, Emily B. Button, Brian Yuen, Megan Gilmour, Kevin Kang, Arvin Bahrabadi, Sophie Stukas, Wenchen Zhao, Iva Kulic, Cheryl L. Wellington, Department of Pathology and Laboratory Medicine, Djavad Mowafaghian Centre for Brain Health University of British Columbia, Vancouver. British Columbia, Canada, V6T 1Z3

**Introduction:** Amyloid plaques, consisting of deposited beta-amyloid (A $\beta$ ), are a neuropathological hallmark of Alzheimer's Disease (AD). Cerebral vessels play a major role in AD, as A $\beta$  is cleared from the brain by pathways involving the cerebrovasculature. Most AD patients have cerebrovascular amyloid, known as cerebral amyloid angiopathy, and cardiovascular risk factors increase dementia risk.

**Aims:** To develop the first functional three-dimensional model of cerebral amyloid angiopathy in bioengineered human vessels.

**Methods:** Three-dimensional scaffold-directed blood vessels consisting of primary human endothelial cells and smooth muscle cells, with or without primary human astrocytes, were generated under flow conditions. Vessels were treated with A $\beta$  at the "brain" side with or without HDL at the "blood" side, followed by analysis of A $\beta$  transport into the circulating medium and accumulation of A $\beta$  in the engineered vessel wall.

**Results:** Brain apoE and circulating HDL synergize to facilitate A $\beta$  transport across bioengineered human cerebral vessels. These lipoproteins facilitate A $\beta$ 42 transport more efficiently than A $\beta$ 40, consistent with A $\beta$ 40 being the primary species that accumulates in CAA. Moreover, apoE4 is less effective than apoE2 in promoting A $\beta$  transport, also consistent with the well-established role of apoE4 in A $\beta$  deposition in AD.

**Discussion:** As circulating HDL synergizes with brain-derived apoE to maintain A $\beta$  solubility and transport from brain to blood, therapeutic strategies to optimize HDL function may be of interest for AD as a complementary therapeutic approach amenable to systemic administration.

### 307 HIV infection and Alzheimer's disease: The integral role of the blood-brain barrier

Michal Toborek and Ibolya E Andras, Department of Biochemistry and Molecular Biology, University of Miami School of Medicine, Miami, FL 33136, USA

**Introduction:** Increased amyloid deposition is characteristic of HIV-1-infected brains, resembling pathology of Alzheimer's disease (AD). It has been hypothesized that brain vascular dysfunction and HIV-1 infection contribute to this phenomenon, with a critical role suggested for the blood-brain barrier.

**Aims:** To evaluate the impact of HIV infection on amyloid metabolism at the blood brain barrier.

**Results and Discussion:** We demonstrated that HIV-1 can elevate amyloid beta levels in human brain endothelial cells and enhance its transendothelial transfer. Mechanistically, we identified the involvement of the receptor for advanced glycation end products (RAGE), lipid rafts, and the dynamin-dependent EEA1 and TGF-beta/Smad signaling pathways in this process. Potentiation of neurotoxic impact of HIV by amyloid beta was reported by us and others in mouse models characterized by amyloid accumulation in the brain. Advanced amyloid plaques are typically surrounded by a microvessel network with substantial capillary leakage, indicating a compromised BBB.

Extracellular vesicles (ECV) are formed by budding from the endosomal membranes, followed by the endosome membrane fusion. ECV were recently postulated to have a significant involvement in various neurodegenerative diseases, including amyloid pathology. Indeed, elevated levels of proteins pathogenic in AD in blood-derived ECV were found to predict the development of AD up to 10 years before clinical onset. Our studies indicate that HIV enhances the number and size of ECV produced by brain endothelial cells and increases their amyloid content. Endothelial-derived ECV can also transfer amyloid cargo into other CNS cells, including neural progenitor cells and astrocytes. Infusion of brain endothelial ECV carrying fluorescent amyloid beta into the internal carotid artery of mice resulted in association of amyloid with brain microvessels and brain parenchyma. These results suggest that ECV carrying amyloid can be successfully transferred across the BBB into the brain. We conclude that HIV-1 facilitates the shedding of brain endothelial ECV carrying amyloid beta; a process that may increase amyloid exposure of cells of neurovascular unit, and contribute to amyloid deposition in HIV-infected brain. Supported by MH072567, MH098891, DA044579, and HL126559.

**308 The cerebral vascular basement membrane: A target for Alzheimer's disease and stroke**

Gregory Bix<sup>1</sup>, Departments of Neurology, Neurosurgery and Neuroscience, University of Kentucky<sup>1</sup>, Lexington, KY, USA

**Introduction:** Alzheimer's disease and ischemic stroke both represent debilitating neurologic conditions in great need of new therapies.

**Aims:** We investigated the pathophysiology and therapeutic potential of domain V (DV), a proteolytic protein fragment of the cerebral vascular basement membrane proteoglycan, perlecan, in mouse models of ischemic stroke and Alzheimer's disease.

**Methods:** Endogenous brain DV expression was evaluated immunohistologically in a mouse model of ischemic stroke (transient middle cerebral artery occlusion). DV was then administered 24 hours after stroke induction to assess its therapeutic potential (infarct size, functional assessment, etc.). The ability of DV to block amyloid-beta (a major effector of Alzheimer's disease) angio- and neurotoxicity, as well as affect its brain clearance was assessed in vitro. Next, DV was administered every 5 days for 6 months to a pdAPP mouse model of Alzheimer's disease to determine whether it could lessen brain amyloid-beta burden.

**Results:** Brain DV levels were rapidly and persistently elevated after experimental stroke. Post-stroke administered DV reduced ischemic brain infarct volume, and improved functional outcomes. DV blocked amyloid-beta angio- and neurotoxicity and enhanced its clearance into brain microvessels in vitro. DV had non-significant effects on total brain amyloid burden in pdAPP mice after 6 months.

**Discussion:** The cerebral vascular basement membrane protein fragment perlecan DV may play an important pathophysiological and therapeutic role in Alzheimer's disease and stroke.

**309 Complementary medicines, health professional responsibilities and trust**

Prof Eleanor Milligan, Griffith University, Brisbane, QLD, Australia

In 2017, the Pharmaceutical Society of Australia (PSA) released a revised Code of Ethics. The new Code provides clear guidance regarding the supply and promotion of complementary medicine stating, *'a pharmacist will only purchase, supply or promote any medicine, complementary medicine, herbal remedy or other healthcare product where there is credible evidence of efficacy and the benefit of use outweighs the risk'*. The Pharmacy Board of Australia's Code of Conduct further clarifies that good care involves *"providing treatment options based on the best available information and not influenced by financial gain or incentives"* and *"practising in accordance with the current and accepted evidence base of the health profession, including clinical outcomes"*.

While it may seem self-evident that any health professional should only promote medications which have evidence of effectiveness, many pharmacies continue to supply medications or products that do not meet this professional standard.

In the complex environment that shapes modern pharmacy practice, this presentation will explore the ethical tensions between patient choice, professional self-interest and trustworthiness, the commercial drivers of practice and the profession's need to maintain public trust.

**310 “What are the potential harms of complementary medicines?”**

Geraldine M Moses, School of Pharmacy, University of Queensland, Brisbane, QLD, Australia

Consumers spend millions of dollars on complementary medicines (CMs) every year. These purchasing decisions are often made on limited and unbalanced information from advertising and promotional material emphasizing the benefit of CMs without much, if any, mention of risk. Unlike registered medicines, CMs do not have to produce a consumer information leaflet to support consumers in their health decision making. Without information about potential benefits AND risks, consumers cannot make informed decisions about their CMs.

So what are the potential risk of CMs? Like any medicine, CMs have potential for adverse effects and drug interactions although finding and retrieving this information may require training. CMs tend not to be subsidized by third parties so their cost, and consultation fees can represent financial harm. Delay in more effective therapy is a potential harm especially for consumers with cancer, when wasting valuable time using ineffective CMs. Health fraud and false hope are well-known and soul-destroying potential harms experienced when vulnerable consumers are preyed upon by unscrupulous purveyors of CMs. Finally, medication burden should be considered a potential harm, as CMs may simply add to the number of medicines being taken, creating the usual risks of polypharmacy including medication error, adverse effects and drug interactions. All these potential risks will be discussed in this presentation using a case-based approach.

**311 Selling complementary medicines and the new Code of Ethics for pharmacists**

Adam La Caze, School of Pharmacy, The University of Queensland.

Many complementary medicines lack compelling evidence of efficacy. The sale of these products in community pharmacy cause a number of ethical challenges. The current *Code of Ethics for Pharmacists* provides the following directive as part of Integrity Principle 1 (h):

A pharmacist will only purchase, supply or promote any medicine, complementary medicine, herbal remedy or other healthcare product where there is credible evidence of efficacy and the benefit of use outweighs the risk.

This talk will examine arguments for and against this directive. I will argue that pharmacists have more responsibilities when recommending complementary medicines as opposed to selling complementary medicines. Good reasons can be given for pharmacists selling complementary medicines in community pharmacy even when these medicines lack evidence of efficacy. These reasons are only compelling, however, if pharmacists meet a number professional responsibilities. These responsibilities include pharmacists ensuring they are available to provide advice to consumers regarding complementary medicines and that the *recommendations* they provide are evidence-based.

**312 Regulating complementary medicines and pharmacy practice**

H Laetitia Hattingh, School of Pharmacy and Pharmacology, Griffith University, Gold Coast, QLD, Australia

Pharmacy practice is regulated at national as well as jurisdictional levels through a hierarchy of legislative instruments. At a national level pharmacists' conduct need to comply with the Pharmacy Board requirements specified in the Board's Code of Conduct and practice guidelines. Additionally, the Board has endorsed standards and guidelines developed by professional organisations and could refer to these as a frame of reference in disciplinary procedures. Specifically in terms of pharmacists' obligations when supplying complementary medicines, several of these documents address practice requirements and the standard of care to be provided by pharmacists and staff members and hence should be complied with.

Complementary medicines are regulated by the Therapeutic Goods Administration (TGA) and most are evaluated as 'low risk' and as such are only listed and not registered on the Australian Register of Therapeutic Goods. The TGA does not individually evaluate listed medicines before they can be available for use in Australia. However the sponsors of listed medicines need to comply with marketing and advertising criteria and may not claim testament of serious diseases.

The regulatory framework with regard to complementary medicines is grey in some areas and open to interpretation. As community pharmacies are a major supplier of these products which are very popular amongst the Australian population it is important for pharmacists to use professional judgement in order to minimise the risk to consumers. Pharmacists have a professional obligation towards consumers when supplying complementary medicines and each pharmacist needs to independently use his/her professional judgement. This presentation will cover the various regulatory aspects that should be considered by pharmacists.

**313 How to reliably measure customers' perceptions of service quality in community pharmacy**

Stephen R Carter<sup>1</sup>, Ardalan Mirzaei<sup>1</sup>, Bethany Grew<sup>1</sup>, Jennifer Chen<sup>1</sup> & Carl R Schneider<sup>1</sup>, Faculty Pharmacy, Uni of Syd, Sydney, NSW, Australia<sup>1</sup>

**Introduction:** Recent changes within community pharmacy have seen a shift towards some pharmacies providing "value-added" services. However, providing high levels of service is resource intensive revenues from dispensing are declining. Many pharmacies have responded by reducing service levels and employing a price-focussed marking strategy (PMFS). Of significance therefore, is how consumers perceive service quality and whether changing service levels changes loyalty. However, at present there are no validated and reliable instruments to measure consumers' perceptions of service quality in community pharmacy.

**Aim:** The aim was to build a theory-grounded model of service quality and to create a valid and reliable survey instrument to measure consumers' perceptions of service quality.

**Methods:** There were 5 steps involved: 1) Item generation using a literature review and semi-structured interviews; 2) Content and face validity testing; 3) Administration to customers of PMFS pharmacies. Exploratory factor analysis (EFA) elucidated the dimensions of service quality and allowed for item reduction. 4) Administration to customers of high service pharmacies. Confirmatory factor analysis (CFA) was used to validate the model; 5) CFA was performed on the combined datasets to test that the instrument was valid for both PMFS and high service pharmacies

**Results:** Initially, 119 service quality items were generated. Content validity testing with 3 pharmacy academics and face validity testing with 9 consumers resulted in 61 items selected. EFA was performed on the data obtained from 4 PFMS pharmacies (n = 687) which revealed 6 dimensions of service quality. CFA performed on the data from 3 high service pharmacies (n=319), confirmed the convergent validity of a 20-item model. Internal consistency was high (all Cronbach  $\alpha$ 's exceed 0.85). Criterion validity was demonstrated as each dimension was highly correlated with loyalty intentions ( $\alpha$  ranged 0.61 - 0.71). Tests of measurement invariance revealed weak invariance between settings.

**Discussion:** A 20-item survey measuring consumers' perceptions of service quality in community pharmacy has been developed and rigorously tested over a period of three years. Statistical analyses demonstrate that the measure is reliable and valid regardless of the level of service provided by the pharmacy.

**314 The safety of transdermal fentanyl initiation in Australian clinical practice**

Natasa Gisev<sup>1</sup>, Sallie Pearson<sup>2</sup>, Briony Larance<sup>1</sup>, Sarah Larney<sup>1</sup>, Bianca Blanch<sup>3</sup>, Louisa Degenhardt<sup>1</sup>, <sup>1</sup>National Drug and Alcohol Research Centre, UNSW Sydney, Sydney, NSW, Australia, <sup>2</sup>Centre for Big Data Research in Health, UNSW Sydney, Sydney, NSW, Australia, <sup>3</sup>The Centenary Institute, Sydney, NSW, Australia

**Introduction:** Safety concerns regarding transdermal (TD) fentanyl initiation have been raised in Australia and internationally due to increasing reports of unintentional fatal overdose resulting from inappropriate prescribing. Although guidelines caution against initiation of TD fentanyl among people who are opioid naïve, there is concern that some patients are not receiving adequate prior opioid exposure in clinical practice.

**Aims:** To determine the proportion of people in Australia that are opioid naïve at the time of transdermal (TD) fentanyl initiation; examine the strengths initiated; and determine the characteristics associated with being opioid naïve.

**Methods:** This was a retrospective population-based cohort study representing a 10% sample of Pharmaceutical Benefits Scheme concessional beneficiaries initiating TD fentanyl between 29 September 2009-31 December 2013. Individuals were deemed to be opioid naïve if they had no opioid dispensings in the previous 90-days. Socio-demographic characteristics, likely comorbidities and previous analgesic use were compared among those opioid naïve/opioid exposed. Logistic regression was used to calculate adjusted odds ratios (aORs) and 95% confidence intervals (CIs) to determine characteristics associated with being opioid naïve.

**Results:** A total of 13,166 people initiated TD fentanyl; 60.4% were females and 76.2% were aged  $\geq 65$  years. Three in ten (30.4%) were opioid naïve and 63.2% initiated the 12 mcg/hr patch. Being opioid naïve was associated with being female (aOR 1.35, 95% CI 1.25-1.46), being older (aOR 1.58, 95% CI 1.33-1.87 for those 65-84 years and aOR 1.84 (95% CI 1.53-2.20) for those  $\geq 85$  years) and having dementia (aOR 1.39; 95% CI 1.06-1.82). Those with a cancer history were less likely to be opioid naïve (aOR 0.57; 95% CI 0.48-0.66).

**Discussion:** Three in ten Australians initiating TD fentanyl are opioid naïve. Our findings suggest that specific patient sub-populations already at increased risk of opioid adverse effects are not receiving prior opioid treatment before initiation, highlighting the need for greater adherence to current treatment guidelines.

**315 Personalized microneedle eye patches by 3D printing to treat Peri-orbital wrinkles with a small peptide**

Seng H Lim<sup>1</sup>, Wen J Tiew<sup>1</sup>, Lifeng Kang<sup>2</sup>. Department of Pharmacy, National University of Singapore<sup>1</sup>, Singapore, Republic of Singapore; Faculty of Pharmacy, University of Sydney<sup>2</sup>, Sydney, NSW, Australia.

**Introduction:** Microneedle (MN) assisted transdermal drug delivery was extensively researched for flat MN patches. However, flat MN patches may be inadequate for efficient drug delivery through the human skin surface, which is undulating in nature. In this study, 3DP was used to fabricate a curved personalized MN patch for anti-wrinkle therapy. Acetyl hexapeptide-3 (AHP-3) was used as the anti-wrinkle drug.

**Methods:** Curved patches with various microneedle geometries were designed and fabricated, via photopolymerisation-based 3D-printing, with various curvatures. These patches were assessed for their respective mechanical strength, skin penetration efficiency and drug delivery efficiency.

**Results:** In general, a longer, sharper and more widely spaced microneedle achieved a better skin penetration efficiency. Furthermore, for each microneedle geometry, patches of intermediate curvatures consistently achieve the best skin penetration efficiency compared to the gentle or sharp curvatures. In all, the optimized geometry was determined to be that of microneedle length 800µm; tip diameter 100µm; interspacing 800µm; and base diameter 400µm. Confocal imaging of the skin sample after in vitro skin permeation using a fluorescence dye, demonstrated enhanced transdermal delivery compared to a commercial flexible microneedle eye patch.

**Discussion:** Microneedle geometry for curved microneedle patches is critical for efficient skin penetration. Using an optimized geometry and actual patient scans, we also demonstrated the use of 3D scanning and 3D printing technology to fabricate a personalized microneedle eye patch for transdermal drug delivery for peri-orbital wrinkles.

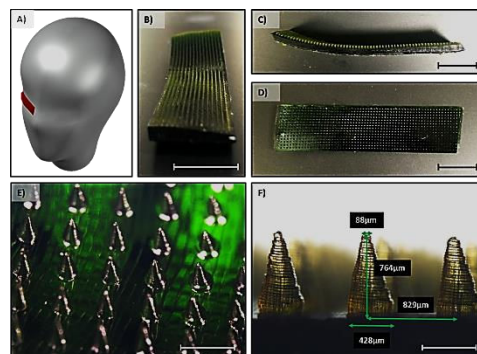

Lim SH, Ng JY, Kang L (2017). *Biofabrication*. 9(1):015010.

**316 The provision of enhanced and extended services in Western Australian community pharmacies**

P. Czarniak<sup>1</sup>, L. Hattingh<sup>1,2</sup>, B. McKay<sup>1</sup>, T.F. Sim<sup>1</sup>, B. Sunderland<sup>1</sup>, School of Pharmacy, Faculty of Health Sciences, Curtin University<sup>1</sup>, Bentley, WA; School of Pharmacy and Pharmacology, Griffith University<sup>2</sup>, Gold Coast Campus, QLD

**Introduction:** Data on the provision of, and remuneration for, enhanced (not routinely provided) and extended (require additional credentialing) services in Australian community pharmacies are limited.

**Aims:** This study aimed to quantify the prevalence of enhanced and extended services provided by Western Australian (WA) community pharmacies, and identify barriers and facilitators to the provision of these services.

**Methods:** A questionnaire was sent to 421 (66.7%) randomly selected pharmacies in WA (303 metropolitan, 118 rural).

**Results:** Of 417 questionnaires, 205 (49.2%) useable questionnaires were returned. The most frequent enhanced service was blood pressure (BP) testing (195; 95.1%) with weekly BP tests ranging from < 6 to > 40 (mean = 8.6) for which 171 (87.7%) pharmacies received no remuneration. Enhanced services funded under the Sixth Community Pharmacy Agreement included the supply of dose administration aids (193; 94.1%), clinical interventions (190; 92.7%), MedsChecks (151; 73.7%) and Diabetes MedsChecks (125; 61.0%). Extended services offered included credentialed compounding (25; 12.2%), diabetes education (5; 2.4%), home medicines reviews (105; 51.2%), residential medication management reviews (13; 6.3%), and pharmacist- (94; 45.9%) and nurse-administered influenza vaccinations (39; 19.0%). The main reasons for offering these services in pharmacies included improved relationships with patients, enhancing the role of pharmacists, for pharmacists' professional satisfaction and to provide health promotion opportunities. Almost all pharmacists (199, 97.1%) agreed that good relationships as well as easy access to a general practitioner (GP) (196, 95.6%) facilitated inter-professional collaboration. Main barriers included time constraints of pharmacists (188, 91.7%), inadequate remuneration (178, 86.8%) and a lack of adequate return on investment (161, 78.5%).

**Discussion:** The health system increasingly relies on community pharmacists to provide services. Although the Sixth Community Pharmacy Agreement has increased the scope for further professional services to be provided, remuneration is limited. In WA alone, approximately 249,626 BP tests are carried out annually for no remuneration. Without improved remuneration options, many community pharmacy services will not be sustainable.

### 317 Reversal of age related pseudocapillarization utilizing VEGF-related, NO-dependent drug treatments on in vitro liver sinusoidal endothelial cells

Nicholas Hunt<sup>1, 2</sup>, Glen Lockwood<sup>1, 2</sup>, Hong Mao<sup>3</sup>, Alessandro Warren<sup>1</sup>, Peter McCourt<sup>2, 3</sup>, David Le Couteur<sup>1, 2</sup>, Victoria Cogger<sup>1, 2</sup>, <sup>1</sup>Biogerontology, ANZAC Research Institute, <sup>2</sup>Charles Perkins Centre, University of Sydney, NSW, Australia, <sup>3</sup>Medical Biology, University of Tromsø, Troms, Norway

**Introduction:** The liver is a key driver in lipid metabolism and the actions of insulin with its function imperative to reducing the risk of metabolic disorders. The transcellular pores, known as fenestrations, within the liver sinusoidal endothelial cells are critical to these functions. With increasing age there is a loss of fenestrations referred to as pseudocapillarization. This impairs transfer of lipids and insulin and contributing to the postprandial hypertriglyceridemia and insulin resistance. The biological regulation of fenestrations is promoted via a VEGF-related, nitric oxide (NO)-dependent pathway to promote either actin or lipid membrane remodeling.

**Aim:** This exploratory study investigated the actions of VEGF-related NO-dependent modifying drugs to promote re-fenestration in old (18-24 months, n=3), compared to young mice (3-4 months, n=3).

**Methods:** Isolated mice LSECs were incubated for 30 mins with 5 drugs active on separate parts of the VEGF-related NO signaling pathway (Drugs A-E). Cells were fixed and prepared for visualization under scanning electron microscopy (SEM), or direct stochastic optical reconstruction microscopy to examine changes in actin organization. SEM images were captured at 10,000x to examine fenestration porosity, diameter and frequency across the cell surface.

**Results:** In both young and old LSECs, increased porosity ( $P<0.05$ ) and frequency ( $P<0.05$ ) were observed for Drugs A, B, D and E; increased diameter ( $P<0.05$ ) was shown in old mice treated with Drug C. Age-related reductions in fenestrations were observed between controls groups, while treatment with Drugs A and B promoted re-fenestration of old LSECs similar to young control mice.

**Discussion:** This preliminary study has shown that promotion of the VEGF-related NO pathway via Drugs A and B promotes re-fenestration in old mice similar to young control mice. These findings demonstrate that the regulation of fenestrations may be performed by NO-dependent pathways and may be regulated *in vivo* by changes in this pathway. Both these drugs demonstrate potential therapeutic use to treat age related pseudocapillarization.

### 318 Cell-specific and biased signalling of a peptide mimetic and small molecule at the relaxin receptor RXFP1

Martina Kocan<sup>1</sup>, Mohammed Akhter Hossain<sup>1</sup>, Chrisan S. Samuel<sup>2</sup>, Roger J. Summers<sup>3</sup>, Ross A.D. Bathgate<sup>1,4</sup>, <sup>1</sup>The Florey Institute of Neuroscience and Mental Health, Parkville, VIC, Australia, <sup>2</sup>Dept of Pharmacology, Monash University, Clayton, VIC, Australia, <sup>3</sup>Monash Inst of Pharmaceutical Sciences, Monash University, Parkville, VIC, Australia, <sup>4</sup>Department of Biochemistry and Molecular Biology, University of Melbourne, Parkville, VIC, Australia

**Introduction:** Relaxin mediates anti-fibrotic, anti-inflammatory, post-injury healing and vasodilatory effects via its cognate receptor, RXFP1. A peptide mimetic, B7-33, and small molecule, ML290, were recently developed and demonstrated to be cell-specific and biased agonists at RXFP1, respectively (Kocan et al., 2017. Sci Rep 7:2968; Hossain et al., 2016. Chemical Science 7:3805-3819).

**Aims:** To use these agonists to better understand signalling at the RXFP1 receptor with particular emphasis on the anti-fibrotic effects of relaxin.

**Methods:** We compared B7-33, ML290 and H2 relaxin-mediated signalling in HEK cells overexpressing RXFP1 (HEK-RXFP1) and cell lines endogenously expressing RXFP1 including primary fibroblasts. We used Surefire, Alphascreen or HTRF assays to investigate short-term MAPK, cAMP and cGMP signalling and applied novel bioluminescence resonance energy transfer (BRET)-based biosensors to investigate spatiotemporal aspects of the p-ERK1/2 and cAMP responses. We also examined longer-term actions on markers of fibrosis (matrix metalloproteinase (MMP)-2 expression and TGF- $\beta$ 1-induced smad2 and smad3 phosphorylation) in human cardiac myofibroblasts.

**Results:** B7-33 was a weak agonist in HEK-RXFP1 cells and some native cells but exhibited equipotent activity to H2 relaxin in other native cells including myofibroblasts. B7-33 stimulated p-ERK1/2 within 10 min in rat renal myofibroblasts whereas 48-72 hour treatment increased MMP-2 expression to an extent comparable to H2 relaxin in human cardiac and rat renal myofibroblasts. In contrast, ML290 was a biased agonist that lacked activity at the p-ERK1/2 pathway in all cell lines tested. Although ML290 did not activate p-ERK1/2 in human cardiac myofibroblasts, it exhibited similar anti-fibrotic effects to H2 relaxin and promoted MMP-2 expression and inhibited TGF- $\beta$ 1-induced smad2 and smad3 phosphorylation; the latter related to its ability to potently activate cGMP.

**Discussion:** The discovery of ML290 and B7-33 has provided valuable tools to dissect downstream actions of RXFP1, especially the association of cGMP and p-ERK1/2 signalling with the long-term anti-fibrotic effects of relaxin.

**319 Investigation of the insulin mimetic effect of *Teucrium polium* in vitro**

Adnan Mannan<sup>1</sup>, Erik Helmerhorst<sup>2</sup>, Marco Falasca<sup>2</sup>, Rima Caccetta<sup>1</sup>, <sup>1</sup>School of Pharmacy, <sup>2</sup>School of Biomedical Sciences, Curtin Health Innovation Research Institute, Faculty of Health Sciences, Curtin University, Perth, WA, Australia

**Introduction:** *Teucrium polium* is a herb that grows in the Mediterranean region. It is widely used by the locals to treat diabetes mellitus. The glucose lowering effect of the extract of this herb *in vivo* has been reported previously from our laboratory.

**Aim:** To investigate whether the constituents of the *Teucrium polium* extract lower blood glucose levels by acting in a similar way to insulin.

**Methods:** The extract was assessed on different insulin sensitive cells in culture. Glucose and glycogen were measured using flow cytometry, fluorometric and colourimetric assays. Proteomics screening of phosphorylated kinases was conducted off shore by Kinexus Bioinformatics Corporation (Canada) as well as Western blots conducted in our laboratory. GLUT4 (insulin-regulated glucose transporter) expression was measured using immunofluorescence microscopy and Western blots.

**Results:** The extract increased glucose uptake in a concentration dependent manner with an apparent efficacy similar to a maximal dose of insulin in 3T3-L1 adipocytes (1.5-fold,  $p < 0.05$ ), differentiated C2C12 muscle cells (1.4-fold,  $p < 0.01$ ) and differentiated L6 muscle cells (1.6-fold,  $p < 0.01$ ). The ability of the extract to promote glucose uptake in differentiated L6 muscle cells coincided with a 3 to 4-fold increase in the expression of GLUT4 ( $p < 0.01$ ). The glycogen content of the differentiated L6 muscle cells increased (1.6-fold,  $p < 0.01$ ) in the presence of either insulin or extract. Phosphorylation of some of the key signaling molecules of the PI3K pathway such as PDK-1, Akt, GSK3 $\alpha$  and p70S6K were significantly ( $p < 0.05$ ) increased, examined in L6 muscle cells, by the extract within 30min. The effect of the extract in promoting glucose uptake and glycogen synthesis in insulin sensitive cells correlated with an increased phosphorylation of several key phosphokinases that are involved in insulin-mediated signaling pathways.

**Discussion:** These findings are consistent with component(s) within the *Teucrium polium* extract promoting both the PI3K/Akt and the Grb2-SOS-Ras-MAPK pathways that are involved in insulin action.

**320 Measuring ligand-binding in endosomes: a signalling platform for pain transmission**

Nicholas Veldhuis<sup>1,2</sup>, Joshua Conner<sup>3</sup>, Quynh Mai<sup>1,2</sup>, Holly Yeatman<sup>1</sup>, Chris Lumb<sup>1</sup>, Bim Graham<sup>3</sup>, Meritxell Canals<sup>1,2</sup>, and Nigel Bunnett<sup>1,2,5</sup>, <sup>1</sup>Drug Discovery Biology, <sup>2</sup>ARC Centre of Excellence for Bio-Nano Science and Technology and <sup>3</sup>Medicinal Chemistry, Monash Institute of Pharmaceutical Sciences, Monash University, Parkville, VIC, Australia

<sup>4</sup>Department of Surgery, Columbia University, New York City, NY, USA

**Introduction:** G protein-coupled receptors can signal from the cell surface and from endosomal membrane compartments to initiate distinct spatiotemporal signalling processes and physiological outcomes. We have recently shown that blocking endosomal-mediated Neurokinin 1 Receptor (NK<sub>1</sub>R) signalling leads to inhibition of central pain transmission when compared to drugs that non-selectively bind throughout the cell (Jensen, 2017). We therefore propose that targeting receptors in endosomes may be therapeutically advantageous. However, quantitative measures for specifically assessing endosomal drug targeting are currently limited and require further development.

**Aims:** To characterise endosomal ligand-receptor interactions of antagonists designed to be delivered to endosomes.

**Methods:** Acceptor photobleaching FRET studies were performed, using SNAP-labelled NK<sub>1</sub>R and synthesised fluorescent probes incorporating spantide (NK<sub>1</sub>R antagonist), cholestanol (lipid raft anchor for endosomal delivery) and fluorescent dye Cy5. Two bioluminescent energy transfer (BRET)-based assays were developed to measure 1) NK<sub>1</sub>R coupling to Arrestin-YFP, and 2) endosomal ligand binding using NanoLuc-NK<sub>1</sub>R and fluorescent Substance P.

**Results:** Acceptor photobleaching FRET studies and BRET-based assays indicate that lipid-anchored antagonists can inhibit arrestin binding. For receptors that can 'escape' this inhibition and still undergo internalisation, lipid-anchored antagonists can achieve ligand binding in endosomes, providing a secondary, additional inhibitory mechanism.

**Discussion:** These studies provide new and valuable approaches for pre-clinical assessment of ligand-receptor interactions in a therapeutically relevant intracellular location. Lipidated antagonists have the potential to inhibit endosomal NK<sub>1</sub>R signalling by blocking: 1) NK<sub>1</sub>R internalisation; and 2) endosomal ligand binding.

Jensen D, et al. (2017) Neurokinin 1 receptor signalling in endosomes mediates sustained nociception and is a viable therapeutic target for prolonged pain relief, *Sci. Transl. Med.*, 9(392): eal3447.

**321 Mutations in the NPxxY motif stabilise different conformational states of the  $\alpha_{1B}$ - and  $\beta_2$ -adrenoceptors**

Lotten Ragnarsson<sup>1</sup>, Åsa Andersson<sup>1</sup>, Walter G Thomas<sup>2</sup> and Richard J Lewis<sup>1</sup>, Institute for Molecular Bioscience<sup>1</sup> and School of Biomedical Sciences<sup>2</sup>, The University of Queensland, Brisbane, QLD, Australia

**Introduction:** G protein-coupled receptors (GPCRs) link diverse extracellular stimuli to a set of intracellular responses that regulate numerous physiological processes in health and disease. Recent crystallographic and biophysical advances in GPCR structure-function have helped clarify our understanding of these dynamic receptors, but the molecular mechanisms associated with activation and signalling for individual GPCRs may be more complex than previously appreciated.

**Aims:** Here we investigated the proposed water-mediated hydrogen bonded activation switch between the conserved NPxxY motif on transmembrane helix (TMH) 7 and a conserved tyrosine in TMH5, which contributes to  $\alpha_{1B}$ -adrenoceptor ( $\alpha_{1B}$ -AR) and  $\beta_2$ -AR activation, with the aim to pharmacologically characterise these major drug targets.

**Methods:** We stabilised inactive state conformations of  $\alpha_{1B}$ - and  $\beta_2$ -ARs by mutating the conserved NPxxY motif and the interacting residue Y<sup>5/58</sup> in TMH5 to destabilise their active state conformations. These inactive state mutants were pharmacologically characterised using  $\alpha_{1B}$ -AR orthosteric (prazosin) and allosteric ( $\rho$ -TIA) inhibitors, and the  $\beta_2$ -AR inhibitor propranolol and partial agonist CGP-1217743, using radioligand binding assays. In addition, we determined alterations in norepinephrine (NE) and isoproterenol signalling through  $\alpha_{1B}$ -ARs and  $\beta_2$ -ARs to inositol 1-phosphate (IP<sub>1</sub>), cAMP and  $\beta$ -arrestin.

**Results:** Inactive state  $\alpha_{1B}$ - and  $\beta_2$ -AR mutants showed decreased potency for agonist-induced IP<sub>1</sub> and cAMP signalling. Surprisingly, inactive state  $\beta_2$ -ARs exhibited decreased agonist affinity, whereas mutations producing inactive state  $\alpha_{1B}$ -ARs had enhanced agonist affinity. Conversely, antagonist affinity was unchanged at both  $\alpha_{1B}$ -AR and  $\beta_2$ -AR inactive state conformations. Furthermore,  $\beta$ -arrestin recruitment was dramatically reduced or abolished at both  $\alpha_{1B}$ -AR and  $\beta_2$ -AR inactive state conformations, whereas measurable agonist potency was little altered. Removing the influence of agonist affinity on agonist potency gave a measure of signalling efficiency, which was dramatically decreased for these  $\alpha_{1B}$ -AR mutants but practically unchanged for  $\beta_2$ -AR inactive state conformations.

**Discussion:** These findings suggest multiple receptor-specific inactive state GPCR conformations with differing pharmacology, which may facilitate rational drug design with distinct pharmacological effects.

**322 Drug delivery to the intestinal lymphatics enhances the immunosuppressant effects of mycophenolic acid in mice**

Ruby Kochappan<sup>1,2</sup>, Sifei Han<sup>1,2</sup>, Luojuan Hu<sup>1,2</sup>, Timothy Quach<sup>2,3</sup>, Danielle Senyschyn<sup>1,2</sup>, Enyuan Cao<sup>1</sup>, Given Lee<sup>1,2</sup>, Fern Lim<sup>2,3</sup>, J.S. Simpson<sup>2</sup>, Justine Mintern<sup>4</sup>, Natalie L Trevaskis<sup>1</sup>, Christopher J.H. Porter<sup>1,2</sup>. <sup>1</sup> Drug Deliv Dispos and Dyn, <sup>2</sup>ARC CoE in Bio Nano Sci and Tech, <sup>3</sup>Med Chem, Monash Inst of Pharm Sci, Melbourne, VIC, Australia, <sup>4</sup>Biochem and Mol Bio, Bio21 Instit, Univ of Melbourne, Melbourne, VIC, Australia.

**Introduction:** The lymphatic vessels that drain the intestine, the gut associated lymphoid tissue (GALT) and the mesenteric lymph nodes (MLN) are central to gut immune surveillance. The intestinal lymphatics also serve to transport dietary lipids (triglycerides, TGs) from the gut to the systemic circulation (Trevaskis et al 2015).

**Aim:** To evaluate the pharmacodynamic benefit of targeting an immunomodulatory agent (mycophenolic acid, MPA) to gut lymphatic immune cells by mimicking the endogenous transport pathway of TGs into the lymph. This was achieved via the design of a TG mimetic prodrug of MPA (MPA-2-TG) (2) to target lymphocytes in intestinal lymph.

**Methods:** The intestinal lymph transport of MPA and MPA-2-TG, was assessed after intraduodenal infusion, by cannulating the mesenteric lymph duct of anaesthetised mice (100 mg/kg ketamine and 10 mg/kg xylazine, ip). Immunosuppression was studied by adoptive transfer of dye labelled CD8+ T cells, purified from lymph nodes (LN) from OT 1 mice, into syngeneic mice fed 50 mg ovalbumin (OVA). Mice were then administered MPA or MPA-2-TG (50 mg/kg) twice daily for 3 days. At the end of the treatment, T cell proliferation in mesenteric and peripheral LNs was evaluated using flow cytometry.

**Results:** The lymphatic uptake of MPA-2-TG (17.3 % dose) was higher than MPA (0.14 %). MPA-2-TG treatment significantly reduced the proliferation of CD8+ T cells in the MLN, with most dye labelled cells (~80%) being found in generation 4 or lower after OVA stimulation. In contrast, MPA had no significant effect on cell replication.

**Discussion:** Targeting lymphocytes in intestinal lymph, via the use of a lipid-mimetic prodrug significantly enhanced the immunosuppressive effects of MPA. This approach may have the potential to enhance the pharmacodynamic benefit of other drugs, such as cytotoxic or immunomodulators that act within the mesenteric lymphatics and MLN.

1. Han S et al (2014) J Control Release 177:1-10.

2. Trevaskis NL et al (2015) Nat Rev Drug Discov 14:781-803.

**323 A randomised controlled trial of patient information leaflets as a medication counselling tool**

Richard McNeill<sup>1</sup>, Paul Chin<sup>1,2</sup>, Elle Coberger<sup>1</sup> Matthew Doogue<sup>1,2</sup>, <sup>1</sup>Dept of Clin Pharmacol, Christchurch Hosp, Christchurch, New Zealand, <sup>2</sup>Dept of Medicine, Univ of Otago, Christchurch, New Zealand

**Introduction:** Counselling patients on medication use has been shown to improve adherence, safety and patient satisfaction. We have developed standardised patient information leaflets (PILs) as medication counselling aids. No studies to date have directly compared different types of written medicines information as counselling aids.

**Aims:** To compare the utility of PILs with a drug monograph as a counselling aid for patients starting a new medication.

**Methods:** A single blinded randomised controlled trial comparing PILs with the New Zealand Formulary monograph (NZF) was undertaken. Medication counselling was assessed using a 5<sup>th</sup> year medical student examination station. Students were block randomised to receive a PIL or NZF drug monograph. Actors were recruited as simulated patients and counselled on starting methotrexate (n=48) or prednisone (n=48). Eight domains of information transfer were assessed by the simulated patients using a Likert scale, 1 (poor) – 4 (good). The primary outcome was overall satisfaction, the remaining domains and a composite score were secondary outcomes. Aid usage was assessed using four secondary outcomes: if the aid was used, how it was used, how long for, and if the aid was given to the patient.

**Results:** There were no differences in information transfer outcomes between the study arms, except for contingency planning which favoured the PIL (PIL 3.4 vs NZF 3.0, P=0.02). Outcomes for aid usage favoured the PIL which was used for longer (P<0.01), more frequently (91% vs 77%, P=0.09), more frequently as a counselling tool (74% vs 40%, P=0.09) and given to the patient more often (58% vs 42%, P=0.15).

**Discussion:** In a medical school clinical examination station of medication counselling, the PIL was as effective as the NZF monograph for patient-assessed information transfer, and superior for specific information regarding managing ADRs. The PIL had higher usage than the NZF monograph, which may reflect greater student satisfaction with the PIL. The strengths of the study included a randomised, blinded methodology with low resource requirements. Future work should involve further evaluation of written medicines information in a clinical context.

**324 “Therapy induced” Takotsubo Cardiomyopathy: Does it matter?**

Gao Jing Ong<sup>1,2</sup>, Thanh Ha Nguyen<sup>1,2</sup>, John D Horowitz<sup>1,2</sup>, <sup>1</sup>Cardiology Unit, Queen Elizabeth Hospital, Woodville, SA, Australia, <sup>2</sup>University of Adelaide, Basil Hetzel Institute, Woodville, SA, Australia

**Introduction:** Takotsubo Cardiomyopathy (TTC) is an acute inflammatory condition mimicking myocardial infarction but occurring mainly in ageing women. The inflammation in TTC represents the results of aberrant β2-adrenoceptor signalling and as such may be precipitated by both endogenous (eg associated with emotional stress) or exogenous catecholamines (CA) surges. TTC has been reported with administration of exogenous CA or agents that potentiate CA effect. B-type natriuretic peptide (BNP) release is markedly increased in TTC, and peak NT-proBNP levels represent an index of attack severity.

**Aims:** We utilised the QEH TTC Registry (between August 2009 and August 2017) to compare patients with and without exogenous CA associated TTC, with emphasis on size of the initial attack.

**Methods:** Patients in whom TTC occurred secondary to life threatening extracardiac disorders (n=4) were excluded, and the remainder categorised according to whether there was presence (CA+) or absence (CA-) of CA enhancing drug administration. Apart from NT-proBNP, demographics and other parameters of attack severity (acute left ventricular ejection fraction [LVEF] or development of hypotension) were compared.

**Results:** Demographics of CA+ patients (n=47) and CA- patients (n=211) did not differ significantly. Tricyclic antidepressants (n=18), mainly in low dose, represent the most common CA source. As would be expected, CA+ patients had marginally higher concentrations of CA metabolite, normetanephrine (p=0.07). However, neither peak NT-proBNP (p=0.98), nor acute LVEF (p=0.61), nor proportion of hypotension (p=0.33) varied between the 2 groups.

**Discussion:** Overall, CA+ patients account for approximately 18% of “primary” TTC cases. However, a similar demographic spectrum and severity of acute attacks applies, irrespective of pharmacological precipitants.

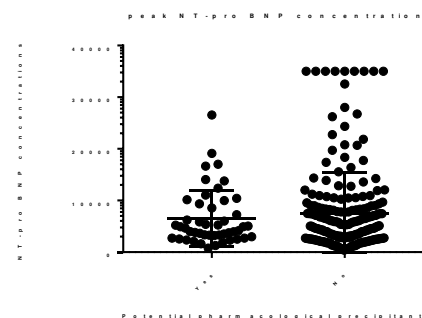

**325 A physiological based pharmacokinetic model to guide dosing of ivacaftor in the presence of pharmacoenhancers**

Angela Rowland, Arduino Mangoni, Tilenka Thynne, Andrew Rowland, Department of Clinical Pharmacology, College of Medicine and Public Health, Flinders University, Adelaide, SA, Australia

**Background:** Ivacaftor is a breakthrough treatment for cystic fibrosis patients that harbour a mutation of the cystic fibrosis transmembrane conductance regulator (CFTR) gene, but is among the highest cost medicines in Australia. It is almost exclusively cleared by CYP3A4-mediated metabolism and exposure is known to be altered by co-administration with strong CYP3A4 inhibitors. CYP3A4 inhibitors have previously been used as “pharmacoenhancers” and when used with Ivacaftor, can reduce the required dose while still achieving comparable plasma concentrations.

**Aim:** This study developed a full physiologically based pharmacokinetic (PBPK) model for ivacaftor to define dosing in the presence of pharmacoenhancers.

**Methods:** Simulations were performed using the Simcyp Simulator® (version 15.1). Ivacaftor absorption was simulated using the ADAM sub-model, and distribution and elimination using a full-PBPK model. Reported pharmacokinetic data was used to construct the ivacaftor profile, then verified against reported age and gender matched trial data using a ratio of simulated to observed area under the plasma concentration time curve (AUC). Secondary analysis compared maximum plasma concentration ( $C_{max}$ ) and AUC at steady state dosing (150 mg BD). The validated model was used to simulate Ivacaftor dosing in the presence of pharmacoenhancers and define potential dosing regimens.

**Results:** Simulated and observed mean ( $\pm$  SD) ivacaftor AUCs following a single dose were 10,014 ( $\pm$ 2925) ng/mL/hr and 10,600 ( $\pm$ 5260) ng/mL/hr, respectively, while simulated and observed mean ( $\pm$ SD)  $C_{max}$  were 801 ( $\pm$ 163) ng/mL and 768 ( $\pm$ 233) ng/mL, respectively. With twice daily dosing, simulated and observed dose accumulation ratios were 2.0 to 3.1 and 2.2 to 2.9, respectively, while the geometric mean comparing simulated to observed parameters were contained within the range 0.9 to 1.1. Statistical comparison (unpaired *t*-test) demonstrated no difference between simulated and observed parameters defining ivacaftor exposure in single or steady-state dosing.

**Conclusions:** Here we report a full-PBPK model defining ivacaftor exposure. This model facilitates the capacity to evaluate the effect of covariates influencing ivacaftor exposure including co-administration of pharmacokinetic enhancers such as ritonavir, and may be applied to interrogate the capacity to exploit the use of such compounds to maintain ivacaftor exposure with a reduced dose intensity either through less frequent dosing or lower doses.

**326 Evaluation of the role and impact of brain computed tomography scans in the assessment of clinically diagnosed overdose cases and an attempt to formulate a procedural framework**

Emma MY Tay<sup>1</sup>, Paul Preisz<sup>2</sup>, Richard O Day<sup>1,3</sup>, <sup>1</sup>Dept of Clinical Pharmacology and Toxicology, St Vincent’s Hospital, Sydney, NSW, Australia, <sup>2</sup>Dept of Emergency Medicine, St Vincent’s Hospital, Sydney, NSW Australia, <sup>3</sup>St Vincent’s Clinical School, UNSW Medicine<sup>3</sup>, Sydney, NSW, Australia

**Introduction:** Patients presenting to hospital with a clinical diagnosis of drug overdose commonly receive a brain computed tomography (CT) scan as part of their admission assessment. Whilst a useful investigation, every CT scan comes with risks including radiation exposure to patient, financial and time costs to the healthcare system.

**Aims:** We aim to evaluate the prevalence, role and impact of brain CT scans in the management of patients with clinical diagnosis of drugs and medicines overdose. We then attempt to formulate a procedural framework for future guidance with reference to brain imaging.

**Methods:** A retrospective study in a single site was conducted at St Vincent’s Hospital, Sydney on all electronic records of patients who presented to the Emergency Department and diagnosed with drug overdose from the 1<sup>st</sup> of May 2014 to the 1<sup>st</sup> May 2016. Outcome measurements were the proportion of patients with a clinical diagnosis of overdose receiving a CT brain within the same hospitalisation episode, and the proportion of patients where CT brain results altered the management within the same hospitalisation episode.

**Results:** A total of 3807 hospital presentation episodes were included, involving 3012 patients. One in ten presentations (11.4%) with a clinical diagnosis of overdose received a CT brain, that is, 437 CT brains were conducted on 410 (13.6%) patients. 182 (41.6%) had a history of head injury. 20 patients received more than one CT brain over the two-year study period. There were 20 abnormal CT scans, but only 10 (2.4%) patients had a change in management due to the abnormal results.

**Discussion:** Our findings showed a high proportion of patients received CT brain imaging, with only a small proportion of patients with abnormal results requiring a change in management during admission. These findings emphasized the importance of a guidance or procedural framework to aid in the management of patients with overdoses, and to minimise the impact of non-indicated radiation risks to patients and operational costs to the health system.

### 327 Real-time review of electronic prescribing of restricted antimicrobials - A pilot of a new antimicrobial stewardship initiative for Christchurch Hospital

Niall Hamilton<sup>1</sup>, QianYi Chuah<sup>1</sup>, Paul Chin<sup>1,4</sup>, Sharon Gardiner<sup>1,2,3</sup>, <sup>1</sup>Department of Clinical Pharmacology, <sup>2</sup>Department of Infectious Diseases, <sup>3</sup>Department of Pharmacy Christchurch Hospital, Canterbury, New Zealand, <sup>4</sup>Department of Medicine, University of Otago, Christchurch, NZ

**Introduction:** Antimicrobial stewardship (AMS) reduces inappropriate antimicrobial use and improves clinical outcomes. Currently, AMS at Christchurch Hospital (CH), New Zealand, includes guidelines overseen by an AMS committee and an active infectious disease consulting service with a specialist antimicrobial pharmacist. The Pharmaceutical Management Agency (PHARMAC) has defined a list of broad-spectrum, toxic and/or high-cost antimicrobials that are restricted to specific specialties or indications. Recent introduction of an electronic prescribing and administration system (MedChart®) at CH presents a potential avenue for assessing adherence to these restrictions via a real-time AMS 'ward round'.

**Aims:** 1. To determine the proportion of interventions likely to be addressed via AMS ward rounds, using MedChart® data to identify inpatients on any restricted antimicrobial. 2. To determine time requirements for these ward rounds.

**Methods:** Medchart® data extracts were conducted three times weekly to identify all new prescriptions for restricted antimicrobials. Electronic clinical records were reviewed to exclude patients who met approval criteria. Physical review of hardcopy notes was then undertaken to identify AMS recommendations.

**Results:** Over the first two weeks, 193 unique prescriptions of restricted antimicrobials were identified. Of these, 25/193 (13%) lacked an indication and required review by the AMS team. From the reviewed clinical notes, 9/25 prescriptions (36%) met CH guidelines. AMS recommendations for the remaining 16/25 (64%) prescriptions were: deescalate to narrower spectrum antimicrobial (6/25, 24%), cease antimicrobial (3/25, 12%), change route of administration (2/25, 8%) or refer for review by the Infectious Diseases service (5/25, 20%). The ward round (conducted by a doctor and pharmacist) took a median of 40 minutes per day (range 10 - 48 minutes).

**Discussion:** An AMS ward round, using MedChart® prescribing data appears feasible, and provides prescribers with immediate feedback on adherence to current antimicrobial guidelines.

### 328 Thyroid immune-related adverse events following PD-1 inhibitors for cancer: Characteristics and associations

Frida Djukiadmodjo<sup>1</sup>, David Liew<sup>1,2</sup>, Jessica Leung<sup>2</sup>, Bonnia Liu<sup>2</sup>, Jonathan Cebon<sup>3</sup>, Russell Buchanan<sup>2</sup>, Albert Frauman<sup>1</sup>, <sup>1</sup>Dept of Clinical Pharmacology and Therapeutics, Austin Health, Heidelberg, VIC, <sup>2</sup>Dept of Rheumatology, Austin Health, Heidelberg, VIC, <sup>3</sup>Olivia Newton-John Cancer and Wellness Centre, Austin Health, Heidelberg, VIC

**Introduction:** Immune checkpoint therapy has proven efficacious in the treatment of multiple cancers, but may cause immune-related adverse events (irAEs) that often mimic known autoimmune conditions. Thyroid irAEs have been described to be the most commonly reported endocrine adverse effect following treatment with programmed cell death protein 1 (PD-1) inhibitors (1). Characterising associations and clinical features of these irAEs might enable us to optimise patient care and may generate hypothesis about spontaneous disease pathophysiology (2).

**Aims:** To describe the frequency and characteristics of thyroid irAEs in a cohort of patients receiving PD-1 inhibitors. Factors associated with the development of thyroid irAEs were sought, including demographic and treatment factors.

**Methods:** All patients who were initiated on nivolumab or pembrolizumab in 2015 and 2016 at our centre were identified through hospital pharmacy dispensing records. A retrospective chart review interpreting existing documentation was performed to identify irAEs as well as patient, disease, and oncological treatment characteristics. Baseline and post-treatment thyroid stimulating hormone (TSH) levels, thyroid autoantibodies and imaging were recorded where available. The management and impact of thyroid irAEs were characterised.

**Results:** Of the 204 patients, thyroid irAEs were diagnosed in 25 (12.3%) patients, making it the most frequent non-cutaneous irAE in our cohort. Thyroid irAEs were more common in patients with an oncological response to therapy (RR 2.18; 95% CI 1.03 to 4.64). Sex, age greater than 70 years, cancer type, cancer stage, combination therapy with ipilimumab and baseline TSH were not found to be associated with an increased risk of developing thyroid irAEs.

**Discussion:** Thyroid irAEs are common in patients treated with PD-1 inhibitors, and are associated with an oncological response to therapy but not with baseline demographic or biochemical features. A prospective systematic investigation would be useful to further investigate mechanisms for the development of these adverse events.

1. Byun DJ et al (2017) Nat Rev Endocrinol. 13: 195-207
2. Delivanis DA et al (2017) J Clin Endocrinol Metab. 102: 2770-2780

### 329 No significant effect of *CYP3A*, *ABCB1*, *POR* and *NR1I2* polymorphisms on acute rejection and nephrotoxicity in the first 3 months post kidney transplantation in patients receiving tacrolimus

Rong Hu<sup>1</sup>, Daniel T Barratt<sup>1</sup>, Janet K Collier<sup>1</sup>, Benedetta C Sallustio<sup>1,2</sup>, Andrew A Somogyi<sup>1</sup>. Disc of Pharmacology, Univ of Adelaide<sup>1</sup>, Adelaide, SA; Dept of Pharmacology, Queen Elizabeth Hosp<sup>2</sup>, Adelaide, SA.

**Introduction.** Tacrolimus is a first line immunosuppressant used after kidney transplantation but with extensive inter-individual variability in PK and PD. Low or high tacrolimus concentrations are associated with acute rejection and nephrotoxicity, respectively. SNPs in its major metabolising enzyme (*CYP3A4/5*), P-glycoprotein efflux transporter (*ABCB1*), their expression regulator Pregnane X Receptor (*NR1I2*), and cytochrome P450 reductase (*POR*), have been studied for their effects on tacrolimus PK (Hesselink et al, 2014; Kurzawski et al, 2017). However, there are few studies on their effects on PD, especially in the first 3 months post-transplantation when acute rejection occurs more frequently.

**Aims.** To investigate the impact of *CYP3A4/5*, *ABCB1*, *NR1I2* and *POR* SNPs on acute rejection and nephrotoxicity in kidney transplant patients receiving tacrolimus in the first 3 months post-transplant.

**Methods.** A total of 165 kidney transplant recipients and 129 donors were included in this study. Biopsy- or clinical observation-confirmed acute rejection, delayed graft function (DGF) and eGFR data were collected from case notes. Acute rejection and DGF were analysed as binomial outcomes (Y/N) while eGFR (unit: ml/min/1.73m<sup>2</sup>) as continuous variables. Genotyping was performed for: *CYP3A5*\*3; *CYP3A4*\*22; *ABCB1* 61A>G, 1199G>A, 1236C>T, 2677G>T, 3435C>T; *POR*\*28; and *NR1I2* 8055 C>T, -25385C>T, 63396C>T. Recipient and donor genotype and predicted *ABCB1* haplotype (PHASE) differences in recipients with acute rejection and DGF in 3 months post-transplant, and 1- and 3-month log-transformed eGFR, were tested by  $\chi^2$  or Fisher's exact tests, and linear mixed effects models, respectively.

**Results.** No recipient or donor genotypes/haplotypes had a significant effect on occurrence of acute rejection ( $P>0.2$ ), DGF ( $P>0.1$ ), or eGFR ( $P>0.02$ ) after adjusting for multiple testing (False discovery rate ( $\alpha=0.05$ ),  $P=0.002$ ).

**Discussion.** Tacrolimus metabolism- and transport-related genetic factors do not significantly affect acute rejection or nephrotoxicity in the first 3 months post kidney transplantation.

[1] Hesselink D.A. et al. (2014) Clin Pharmacokinet, 53(2): 123-39.

[2] Kurzawski M. et al. (2017) Pharmacogenet Genomics. 2017;27(10):372-7.

### 330 HLA-B status leading to potential severe adverse drug reactions in Aboriginal Australians

Andrew A Somogyi<sup>1</sup>, Daniel T Barratt<sup>1</sup>, Discipline of Pharmacol, Univ of Adelaide<sup>1</sup>, Adelaide, SA

**Introduction:** Life-threatening adverse drug reactions have been linked to specific HLA genotype status with ethnicity as a defining factor (Somogyi & Phillips, 2017). Some prescribing guidelines recommend pre-emptive genotyping of *HLA-B\*15:02* for carbamazepine-induced Stevens-Johnson syndrome/toxic epidermal necrolysis. Little is known about the HLA-B medicines-related status of Aboriginal Australians.

**Aims:** To determine the HLA-B status of Aboriginal Australians (AA) and non-Aboriginal Australians (NA) for *HLA-B\*57:01* (abacavir), *B\*58:01* (allopurinol), *B\*15:02* (carbamazepine), *B\*13:01* (phenytoin- Han Chinese) and *B\*56:02* (phenytoin - Aboriginal Australians (Harding et al, 2012)).

**Methods:** Following ethics committees' approvals and informed consent, participants provided a saliva sample for DNA isolation which was tested for HLA status using Sanger sequencing. In addition, data were also obtained from the Aboriginal communities in Cape York Peninsula (n=103), Groote Eylandt (n=75), Kimberly (n=45) and Yuendumu (n=191) (Takeshita et al, 2015), hereafter referred to as Other Sites.

**Results:** Thirty-two self-identified Aboriginal Australians and 36 non-Aboriginal participants' samples and data were obtained. For *HLA-B\*57:01* the incidence was 1.6% and 1.4% (AA vs NA) and was 0.7-1.5% in the Other Sites; for *HLA-B\*58:01* it was 0% vs 2.8% and 0-0.7% (Other Sites), *B\*15:02* (1.6% vs 0%; 0-0.7%- Other Sites); *B\*13:01* (4.7% vs 0%; 12-27% Other Sites) and for *B\*56:02* its was 3.1% vs 0% and 1.3-19% Other Sites.

**Discussion:** The study shows that Aboriginal Australians would be less vulnerable to allopurinol hypersensitivity (*B\*58:01*), similar to Caucasians for abacavir hypersensitivity (*B\*57:01*), and to the predominantly Han Chinese phenytoin hypersensitivity (*B\*13:01*), and highly vulnerable to phenytoin hypersensitivity due to *B\*56:02* which is almost non-existent in Caucasian and Asian populations.

Somogyi AA and Phillips E (2017). Aust Prescr 40:101-4

Harding DJ et al (2012) Med J Aust 197:411-4

Takeshita LY et al (2015) Nucl Acid Res 28: D784-8

**331 Potential simple and multifactorial drug and gene interactions of tricyclic antidepressants in older Australians**

Mohitosh Biswas<sup>1</sup>, Thilani H. Dias<sup>1</sup>, Nilofar Daneshi<sup>1</sup>, Elizabeth Holliday<sup>2</sup>, Stephen Hancock<sup>2</sup>, John Attia<sup>2</sup>, Rodney Scott<sup>1</sup>, David Newby<sup>2</sup>, Karen P. Kerr<sup>1</sup>, Elizabeth A. Milward<sup>1</sup>, <sup>1</sup>School of Biomed Sci and Pharmacy, The University of Newcastle, Newcastle, NSW, Australia, <sup>2</sup>School of Med and Pub Health, The University of Newcastle, Newcastle, NSW, Australia

**Introduction.** Safety and efficacy of tricyclic antidepressants (TCAs) may be reduced when co-prescribed with interacting drugs or due to genetic variants or both (Hicks 2013).

**Aims.** To determine the prevalence of potential simple and multifactorial drug and gene interactions (DGI) of TCAs in older Australians where polypharmacy is common.

**Methods.** Co-prescribed interacting drugs were identified from self-reported medication data of 2,642 participants aged over 55 in the Hunter cohort community study (McEvoy 2010). Predicted drug and gene interactions were identified for gene variants determined from genotyping data obtained using Affymetrix Kaiser Axiom arrays and imputed data from the 1000 Genomes and HapMap Phase II European reference panels.

**Results.** Of 57 participants on TCAs, 47 (83%; 95% CI 73%-92%) were co-prescribed at least one potential interacting drug, with on average 2.5 possible interactions per participant. About 22% of participants (95% CI 8%-36%) had clinically actionable genotypes and 16% (95% CI -1%-32%) were at risk of multifactorial DGI predicted to increase the likelihood of adverse effects.

**Discussion.** Considerable proportions of older people in the community using TCAs may be at increased risk of adverse reactions involving drug-gene interactions that may justify dose reduction. The findings emphasize the potential value of considering the pharmacogenomics of TCAs in conjunction with drug interaction analyses.

Hicks JK et al (2013) Clin Pharmacol Ther 93:402-408

McEvoy M et al (2010) Int J Epidemiol 39:1452-1463

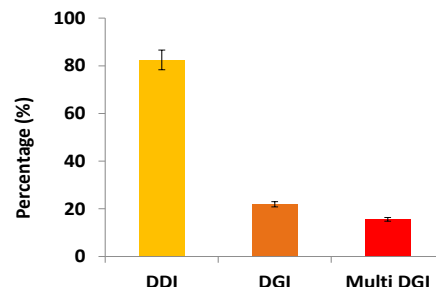

Figure: Potential simple and multifactorial DGI of TCAs in older Australians

**332 Signalling modification by Single Nucleotide Polymorphisms in the third intracellular loop of the mu-opioid receptor**

Marina Santiago & Mark Connor. Dept of Biomedical Sciences, Macquarie Univ, Sydney, NSW, Australia

**Introduction:** The third intracellular loop (ICL3) is a highly conserved region of opioid receptors and it is involved with G protein coupling. Three rare human mu-opioid receptor (MOPr) SNPs have been previously reported (R260H, R265H and S268P) to affect receptor signalling (Knapman et al 2015). This could be a result of impaired G protein coupling and phosphorylation site deletion (S268P). Changes in signalling, phosphorylation and internalisation of these receptor variants may explain some of the variability in clinical responses to opioids and understanding them may contribute to understanding the role of ICL3 in MOPr signalling and regulation.

**Aims:** In this *in vitro* study, we explored the effects of these MOPr ICL3 SNPs on signalling and regulatory pathways induced by morphine and the endogenous opioid analogue DAMGO in the pituitary cell line AtT-20.

**Methods:** AtT20-FLPIn cells were stably transfected with human WT, R260H, R265H, S268P and S268A MOP. Receptor levels were determined using [<sup>3</sup>H]-DAMGO binding assays. MOP-induced K channel activation and signal desensitisation was measured with a membrane potential-sensitive dye in a Flexstation 3. Agonist-induced MOP phosphorylation at Ser377 and loss of cell surface MOPr were determined by Western blot and ELISA, respectively.

**Results:** DAMGO binding was within 30% of WT in each variant. At S268P, DAMGO potency was significantly reduced when compared to both WT and S268A (pEC50 WT 8.4±0.1; S268P 7.8±0.1; S268A 8.4±0.1 (n=6, P<0.05)). Phosphorylation of Ser377 was only affected at R260H mutation, where phosphorylation in response to DAMGO (1µM) was decreased by over 50%. 30 minutes exposure to DAMGO (10 µM) also produced less loss of surface R260H receptor (14±8%) compared to WT MOP (36±8%).

**Discussion:** The importance of the ICL3 MOPr for G protein signalling was confirmed by this study. Changes in the N-terminal region of the ICL3 had a greater effect on G protein coupling, while only R260H affected receptor regulation. By using S268A we determined that phosphorylation at S268 site is not crucial for pathways studied. All SNPs have the potential to affect opioid response in patients but the effect in heterozygous genotype need further investigation.

Knapman A et al (2015) Br J Pharmacol 172:349-363

### 333 *ABCB1* pharmacogenetics in Papua New Guinea HIV/AIDS patients and association with efavirenz CNS/Psychiatric adverse effects

Helena Van Schalkwyk<sup>1</sup>, Joseph Tucci<sup>2</sup>, Paul Pumuye<sup>3</sup>, Daniel Barratt<sup>1</sup>, Andrew A Somogyi<sup>1</sup> Disc Pharmacol, Univ Adelaide<sup>1</sup>, Adelaide, SA; Dept of Pharmacy & Applied Science, La Trobe Univ<sup>2</sup>, Bendigo, Vic; School of Medicine and Health Sciences, Univ Papua New Guinea<sup>3</sup>, Boroko, Papua New Guinea.

**Introduction.** Papua New Guinea (PNG) has the highest prevalence of HIV/AIDS in the Pacific with efavirenz as the main treatment. *ABCB1* encodes the P-glycoprotein efflux transporter which is important for drug disposition, and *ABCB1* genotype has been linked to efavirenz CNS/Psychiatric adverse effects (Dickinson et al., 2016). However, nothing is known about key *ABCB1* SNPs in the PNG population. We hypothesised that *ABCB1* genetics would be associated with efavirenz CNS/Psychiatric adverse effects in PNG HIV/AIDS patients.

**Aims.** To determine the frequency of *ABCB1* 61A>G, 1199G>A, 1236C>T, 2677G>T and 3435C>T SNPs and haplotypes in PNG HIV/AIDS patients receiving efavirenz and examine genotype/haplotype differences in the incidence of CNS/Psychiatric adverse effects.

**Methods.** Demographic and clinical data, including CNS/Psychiatric adverse effects, and saliva were collected from 51 PNG HIV/AIDS patients. Salivary DNA was genotyped for *ABCB1* SNPs and allele frequencies compared to other populations (Caucasian, East Asian, African) (Auton et al., 2015). *ABCB1* haplotypes were inferred by PHASE. Incidence of CNS/Psychiatric adverse effects was compared between *ABCB1* genotypes and haplotypes by Fisher's exact tests.

**Results.** PNG HIV/AIDS patients have a high frequency of 1236T (82%), 2677T (62%) and 3435T (66%) alleles compared to other populations (14-63%, 0-13% and 15-52%, respectively). No variant alleles were observed for 61A>G and 1199G>A. There were no significant genotype/haplotype differences in CNS/Psychiatric adverse effects ( $p > 0.15$ ).

**Discussion.** PNG HIV/AIDS patients exhibit very high frequencies of key *ABCB1* SNPs which may have important implications for P-glycoprotein substrate drugs in this population. However, no significant association with efavirenz adverse effects was detected in this small study, and larger studies incorporating efavirenz PK are required.

Dickinson et al. (2016) Clin Pharmacokinet 55:861-873.

Auton et al. (2015) Nature 526:68-74.

### 334 Interleukin genetics and not *COMT* or *OPRM1* may affect risk of persistent pain following total knee arthroplasty

Daniel Barratt<sup>1</sup>, Hellen Victory<sup>1,2</sup>, Lona Christrup<sup>2</sup>, David Rice<sup>3,4</sup>, Michal Kluger<sup>3</sup>, Peter McNair<sup>4</sup>, Gwyn Lewis<sup>4</sup>, Andrew Somogyi<sup>1</sup>, <sup>1</sup>Disc Pharmacol, Univ Adelaide, Adelaide, SA, <sup>2</sup>Dept Drug Design & Pharmacol, Univ Copenhagen, Copenhagen, Denmark, <sup>3</sup>Dept Anaesthesiology & Perioperative Medicine, Waitemata District Health Board, Auckland, New Zealand, <sup>4</sup>Health & Rehabilitation Research Inst, Auckland Univ Technology, Auckland, New Zealand

**Introduction:** Total knee arthroplasty (TKA) is a common procedure intended to alleviate pain, but up to 30% of patients experience persistent postsurgical pain (PPP) that lasts months to years after surgery. Identifying factors such as patient genetics that predict PPP can assist in its prevention and treatment. SNPs in catecholamine, opioid, and immune signalling pathway genes have been linked to PPP in other surgical settings (Hoojwijk et al, 2016). We hypothesised that SNPs in these pathways would also be associated with PPP following TKA.

**Aims:** To investigate *COMT*, *OPRM1* and immune genotype differences in the likelihood of PPP following TKA.

**Methods:** Patients were 264 Caucasians scheduled for primary TKA and followed 6 months post-surgery. PPP was classified as a numerical rating scale pain score  $\geq 3$  6 months after surgery. DNA from blood was genotyped for 17 SNPs (minor allele frequency  $> 5\%$ ) in *COMT*, *OPRM1*, *IL1B*, *IL2*, *IL6*, *IL6R*, *IL10*, *CASP1*, *CRP*, *TLR2*, *TLR4*, *MYD88*, *TGFB1* and *TNFA*. Genotype differences in PPP were analysed by forward selection (ANOVA  $P < 0.05$ ) logistic regression controlling for patient age and acute post-surgical pain (Western Ontario and McMaster Universities Osteoarthritis Index score [0-100] with movement 24 hours after surgery).

**Results:** Seventy-eight patients (30%) had PPP. The likelihood of PPP was lower for variant genotypes of *IL6* -6331T>C (rs10499563) (adjusted odds ratio [95% CI] versus T/T: T/C = 1.2 [0.65 to 2.4]; C/C = 0.13 [0.01 to 0.73];  $P = 0.03$ ) and *IL2* -330T>G (rs2069762) (T/G = 0.55 [0.28 to 1.0]; G/G = 0.22 [0.03 to 0.87];  $P = 0.04$ ). *COMT* (rs4680, rs4818) and *OPRM1* (rs1799971) genotypes were not significantly associated with PPP ( $P > 0.2$ ).

**Discussion:** Genetic variability in interleukin signalling, and not *COMT* or *OPRM1*, may affect predisposition to PPP following TKA, although these associations were not statistically significant after correction for multiple testing. Additional genetic factors associated with PPP in other surgical settings are still to be investigated in this TKA cohort.

Hoojwijk D et al (2016) Br J of Anaesth 117:708-19

**335 Best Possible Medication History Gamification – Development and pilot study**

Paulina Stehlik<sup>1</sup>, Vien T. Truong<sup>2,3</sup>, Rebekah J. Moles<sup>2</sup>, Carl R. Schneider<sup>2</sup>, <sup>1</sup>CREBP, Bond Uni, Gold Coast, QLD, Australia, <sup>2</sup>Faculty of Pharmacy, Uni of Sydney, Sydney, NSW, Australia, <sup>3</sup>Dept of Pharmacy, Campbelltown Hosp, Sydney, NSW, Australia

**Introduction:** This study describes the development and pilot of an electronic adaptation of the Medication Mysteries Infinite Case tool (eMedRec). eMedRec provides an opportunity for students to simulate the history taking and documentation process, provide guided peer feedback and receive instant grading of history documentation accuracy.

**Aims:** To evaluate the game's impact on students' self-perceived confidence and competence, and to evaluate game usability.

**Methods:** Game and survey data were used to measure outcomes. Changes in self-rated confidence and competence scores of second-year Master of Pharmacy students in semester 1 (usual teaching: one medication history taking lecture, weekly problem based learning (PBL) tutorials, and four weeks of clinical placement) was compared to semester 2 (intervention: use of the eMedRec game and PBLs in weekly tutorials). System Usability Scale (SUS) was used to measure game usability.

**Results:** Changes in self-perceived confidence were equivalent during semester 1 control and semester 2 intervention (0.45 v 0.13; difference in mean change = -0.32, 95% CI = -0.72 to 0.08). There was a significant increase in self-perceived competence following eMedRec exposure in semester 2 (-0.06 v 1.16; difference in mean change = 1.23, 95% CI = 0.66 to 1.81). eMedRec SUS score was 48.5/100.

**Discussion:** eMedRec scored moderately on the SUS, despite significant server issues throughout the study period. We observed similar increase in self-perceived competence and greater increase in student self-perceived competence after intervention compared to usual teaching. Further evaluation of the game is warranted.

Sando KR, Elliott J, Stanton ML, Doty R. (2013) Am J Pharm Ed. 77(5):105.

**336 Engaging students in learning outcomes and career relevance through a multi-dimensional, interactive map – MyCourseMap**

Lisa BG Tee<sup>1</sup>, Ieva Stupans<sup>2</sup>, Jose Manuel Serrano Santos<sup>3</sup>, <sup>1</sup>School of Pharmacy, Curtin University, Perth, WA, <sup>2</sup>School of Health and Biomedical Sciences, RMIT University, Bundoora, VIC, <sup>3</sup>School of Clinical Sciences, Queensland University of Technology, Brisbane, QLD, Australia

**Introduction:** Undergraduate students rarely see a program-wide view of their studies, and yet their programs are developed with just such a holistic view. Often the curriculum intent including program learning outcomes and graduate attributes are not "visible" to students. Degree structures are often difficult to comprehend and opaque to commencing students due to the complexity of the course information. The tool—*MyCourseMap*—utilises digital-touch technology and is designed for use on all mobile devices. *MyCourseMap* presents curriculum in a more student-centred and visible form and is used in this study.

**Aims:** To gather and evaluate the perception of students and staff regarding their awareness of the importance of graduate attributes and program learning outcomes. To also gather the perception of academics who have trialed the *MyCourseMap* tool regarding the benefits and barrier in using the tool.

**Methods:** The *MyCourseMap* tool was trialed in a few institutions across Australia. The perspectives of staff and students on visibility and awareness of curricula, graduate attributes and program learning outcomes for the Bachelor of Pharmacy were investigated. Specifically, participants attended a workshop presentation, followed by focus group discussion. Participants were also requested to complete an online survey following the focus group discussion.

**Results and discussion:** Preliminary result from online survey regarding the visibility of graduate attributes indicates an increased the percentage of respondents from 38% to 93% when the curriculum was presented using the *MyCourseMap*. Similarly there was an increased in the perception regarding visibility of program learning outcomes, an increased from 50% to 90%. Academics who have trialed the *MyCourseMap* valued the ease of set up and maintenance of the information, the cross-discipline applicability and the potential of the tool for other purposes such as visualisation and mapping of professional domains and competencies in a course. *MyCourseMap* allowed for ready identification of potential assessment issues and provided impetus for minor curriculum redevelopment.

### 337 “Visual thinking strategies” in early pharmacy undergraduate education can support the development of professional communication and cultural competencies

Trudi Aspden<sup>1</sup>, Lynne Petersen<sup>1</sup>, School of Pharmacy, University of Auckland<sup>1</sup>, Auckland, New Zealand

**Introduction:** Visual Thinking Strategy (VTS) described by Yenawine P (2013) uses art to develop transferable skills. In 2016 we introduced VTS sessions in year 2 of our revised BPharm programme to assist students to apply learning from the Hauora Māori (Māori Health) and Clinical and Professional Skills domains to other areas of the BPharm curriculum.

**Aims:** To describe the implementation and refinement of VTS learning activities, and early assessment of the impact of VTS on developing professional competencies such as critical thinking, cultural competence and communication skills.

**Methods:** A series of deliberately themed images were used in 10 VTS workshops and linked across various activities, including a poverty simulation, a cross-cultural simulation, reflections on learning and an inter-professional Māori Health Intensive module. These all linked to the patient-centred communication frameworks developed by the part II teaching team that are used by students within practice lab sessions and are incorporated into assessments.

**Results:** Tutor and student feedback indicates that students’ oral communication skills have improved: specifically their ability to listen actively, to link their ideas to those of others, and to respectfully offer alternative viewpoints. Modifications to the VTS sessions have been made based on student and tutor feedback; these include reducing VTS class sizes to <15 participants and offering students a choice of images to discuss in each session.

**Discussion:** We adapted Visual Thinking Strategy (VTS) methodology for use with adult learners and pharmacy contexts in New Zealand, and deliberately linked this to other activities relating to culture, communication and personal development in the curriculum and to the Pharmacy Council of New Zealand’s Competence Standards for the Pharmacy Profession. VTS appears to have been a valuable addition to the curriculum, offering opportunities for students to integrate learning and transfer skills and knowledge across the curriculum. A comprehensive evaluation plan is being implemented in order to understand critical features of the VTS method and implications for teaching such as the extent to which students transfer VTS ‘thinking and practices’ to other domains of their learning.

Yenawine P (2013) Visual Thinking Strategies: Using art to deepen learning across school disciplines. Cambridge, Massachusetts: Harvard Education Press.

### 338 Experiences developing a pharmacology online careers portal: Evaluating impact on student career awareness

Barbara K Kemp-Harper, Emma Harris, Elizabeth A Davis, Dept Pharmacology, Monash University, Clayton, VIC, Australia

**Introduction:** Students undertaking courses without a defined vocational outcome (e.g. B.Sc, B.Biomed.Sci) are not always aware of potential career pathways, which can affect their motivation and engagement. In addition, they have little knowledge of the specific resources available to help prepare them for future employment.

**Aim:** The current study aimed to heighten the career awareness of pharmacology students, via the development, implementation and evaluation of an online careers portal with a focus on the pharmaceutical industry.

**Methods:** A Monash Pharmacology Alumni LinkedIn group was established, with graduates invited to join the group and participate in an on-line survey and/or video interview, focused on the nature of their job, their career journey and relevant skills required. A website was established, using the information they provided. Undergraduate students (n=58) enrolled in a third year pharmacology unit (semester 2, 2017), were invited to complete surveys pre- and post-implementation of the website. The surveys assessed students’ knowledge and understanding of jobs within the pharmaceutical industry and resources available to help them prepare for future careers.

**Results:** To date, 62 Monash graduates have joined our LinkedIn group and 22 have completed the online survey. The survey information formed the basis of the careers website, providing an overview of jobs within the pharmaceutical industry and highlighting profiles of alumni. Eleven of the alumni completed video interviews, which were incorporated into the website. Prior to access to the online resource, students identified research (85%) and sales representatives (70%) as roles within the pharmaceutical industry of which they were aware. The majority of students (64%) indicated that they would use Google and/or speak to academic staff (40%) to obtain further information about career prospects. Student survey data post implementation of the website is pending. Feedback on the website from alumni participants has been positive. An unexpected outcome of the project has been the development of an alumni network, some of whom are now engaged in teaching activities within our department.

**Discussion:** Access to our online careers portal has the potential to increase awareness of career pathways available to pharmacology students. The alumni network will facilitate opportunities for student engagement with industry.

## 339 Exploring the use of a novel computer-based interactive pharmacy simulation program in university and professional pharmacy practice education

Kenneth Lee<sup>1</sup>, Bryan Etherington<sup>1</sup>, Lauren Tait<sup>2</sup>, Mackenzie Williams<sup>1</sup>, Joyce Cooper<sup>3</sup>, Rohan Rasiah<sup>4</sup>, Benjamin Geelan<sup>1</sup>, Tristan Ling<sup>1</sup>, Ivan Bindoff<sup>1</sup>, <sup>1</sup>Pharmacy, University of Tasmania, Hobart, TAS, Australia, <sup>2</sup>Pharmacy Department, Townsville Hospital, Townsville, QLD, Australia, <sup>3</sup>School of Biomedical Sciences and Pharmacy, University of Newcastle, Newcastle, NSW, Australia, <sup>4</sup>Western Australian Centre for Rural Health, University of Western Australia, WA, Australia

**Introduction:** Experiential learning with repeated practice allows learners to consolidate knowledge and skills in a contextualised environment. A high fidelity, computer-based simulated environment has the potential to facilitate safe experiential learning and provide unlimited practice opportunities.

**Aims:** We aimed to 1) compare the use of various simulation modalities against a novel computer-based pharmacy simulation program ('Pharmacy Simulator'), 2) explore pharmacists and pharmacy students' perceptions and experiences with using the aforementioned program as an experiential learning tool, and 3) assess the need for the aforementioned program in pharmacy practice education.

**Methods:** We used a series of nested mixed-method studies to address the aforementioned aims: study 1 (Aim 1) was a randomised cross-over of simulation modalities, study 2 (Aim 2) used a pre-post intervention design with pharmacists and pharmacy students. Study 3 (Aim 3) gathered qualitative feedback from key stakeholders including pharmacists, pharmacy organisations, pharmacy students, and universities.

**Results:** Overall, participants were typically in favour of the use of 'Pharmacy Simulator' as a learning tool, perceived the program to have positive effects on confidence to practice, and agreed there is a place for 'Pharmacy Simulator' as an additional resource for experiential learning within universities and professional training organisations.

**Discussion:** Results suggest a positive uptake of 'Pharmacy Simulator' when used as a supplementary learning tool, as while it has comparable efficacy, it offers different benefits that extend typical experiential learning approaches.



## 340 The journey of a prescription: An interprofessional education simulation of the patient and prescription flow through prescriber and dispenser

James A Green<sup>1</sup>, Jim Ross<sup>1</sup>, Rhiannon Braund<sup>1</sup>, Martyn Williamson<sup>1</sup>, Tony Egan<sup>1</sup>, <sup>1</sup>School of Pharmacy, University of Otago, Dunedin, New Zealand, <sup>2</sup>Department of General Practice and Rural Health, University of Otago, Dunedin, New Zealand

**Introduction:** Interprofessional education has been an increasing area of emphasis in health professional training, but exercises at the immersion level, where students are embedded in their professional roles are more challenging to design than exercises involving exposure to or engagement with other professions.

**Aims:** To investigate the feasibility of running a series of simulated pharmacies alongside an existing simulated medical clinic, as an interprofessional education exercise.

**Methods:** We ran a pilot project with 8 pharmacy students operating 4 simulated pharmacies, alongside a simulated medical practice with 18 medical students operating in pairs, with 23 actors serving as patients. Following 2 hours of simulation, students participated in a focus group/debrief in mixed profession groups.

**Results:** Overall, the session ran smoothly, despite the considerable complexity in setting up temporary pharmacies with computer software and stock, and managing the flow of patients and prescriptions between the medical and pharmacy settings. Analysis of the focus group/debrief transcripts showed that students found the experience beneficial and more authentic than their usual simulation experiences, and that they learned a lot about each other's' roles. We also had visitors from other health professional programmes, and are exploring how they could be integrated in the future.

**Discussion:** This successful pilot provides a model for further interprofessional education development. Through the simulation exercise and debrief discussion, both groups of students were able to learn about each other's roles in obtaining good outcomes for their shared patients.